

*Champion*  
SURGICAL CO.

**Dental  
Instruments**



**Catalogue**  
**New Collection**



**Incisors And Cuspids 1**

**CS-51-001**

Tooth Ext Forceps

Fig -1

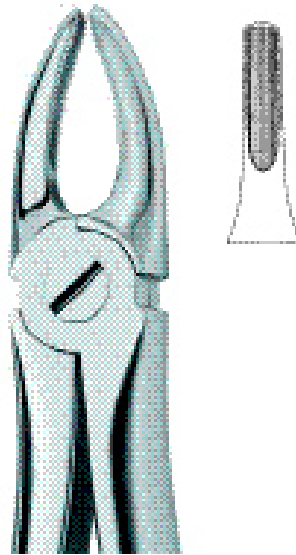

**Incisors And Bicuspid 2**

**CS-51-002**

Tooth Ext Forceps

Fig -2



**Lower Incisors And Canines 4**

**CS-004**

Tooth Ext Forceps

Fig -4

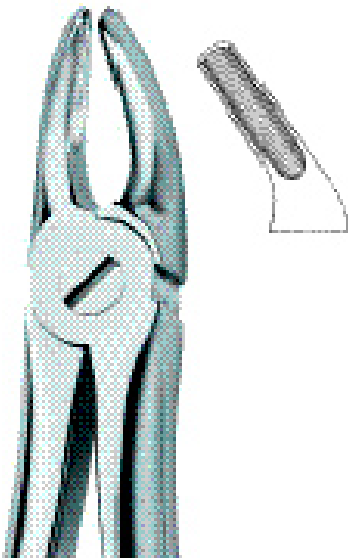

**Bicuspid 7**

**CS-51-007**

Tooth Ext Forceps

Fig -7



**Lower Bicuspid, Universal 13**

**CS-51-013**

Tooth Ext Forceps

Fig -13

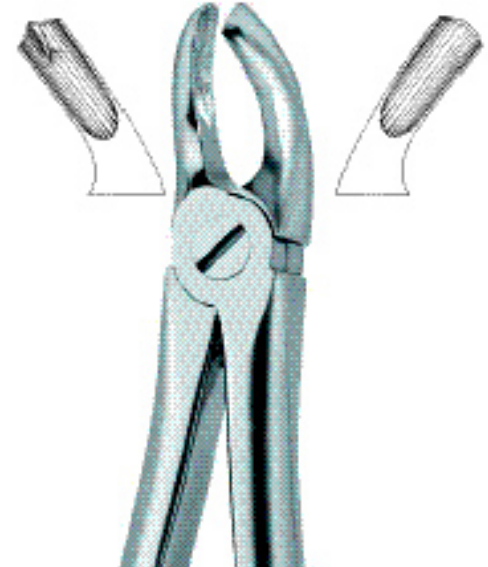

**Molars, Right 17**

**CS-51-017**

Tooth Ext Forceps

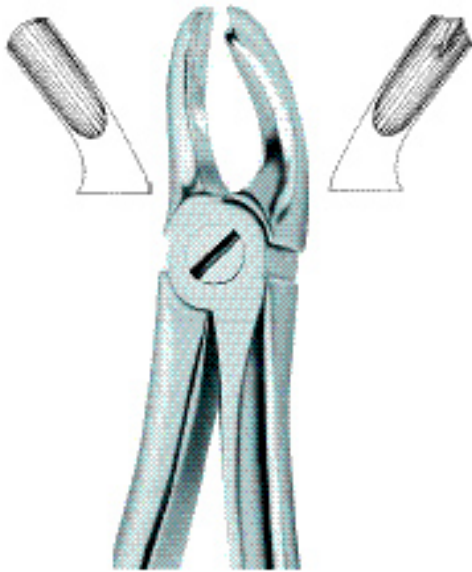

**Molars, Left 18**

**CS-51-018**

Tooth Ext Forceps

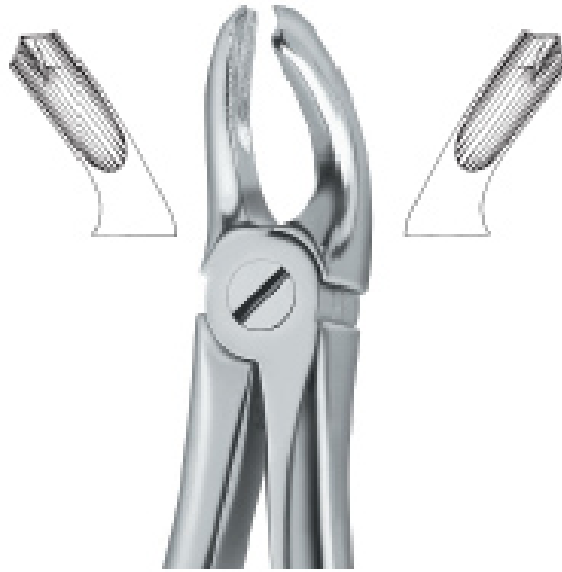

**Molars 18A**

**CS-51-018-01**

Tooth Ext Forceps



**Lower Molars, Universal 22**

**CS-51-022**

Tooth Ext Forceps

Fig -22



**Lower Molars, Right 23**

**CS-51-023**

Tooth Ext Forceps

Fig -23



**Lower Molars, Left 24**

**CS-51-024**

Tooth Ext Forceps

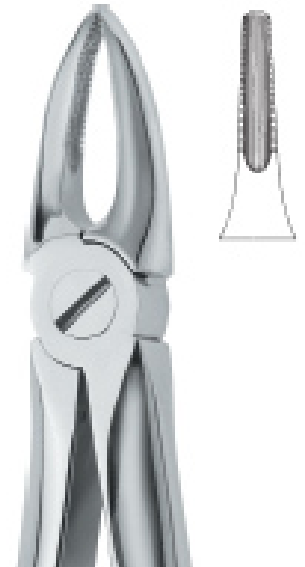

**Upper Roots And Incisors 29**

**CS-51-029**

Tooth Ext Forceps



**Lower Roots 33**  
**CS-51-033**  
Tooth Ext Forceps



**Lower Roots 01**  
**CS-51-033-01**  
Tooth Ext Forceps



**Lower Roots 03**  
**CS-51-033-03**  
Tooth Ext Forceps



**Lower Roots 06**  
**CS-51-033-06**  
Tooth Ext Forceps



**Incisors And Bicuspids 34N**  
**CS-51-034**  
Tooth Ext Forceps  
Fig -34N



**Incisors And Bicuspids 35N**  
**CS-51-035**  
Tooth Ext Forceps  
Fig -35N



**Tooth Ext Forceps**

**CS-51-036**

Tooth Ext Forceps



**Lower Roots 46**

**CS-51-046**

Tooth Ext Forceps



**Lower Roots 46**

**CS-51-046-01**

Tooth Ext Forceps



**Lower Roots 46**

**CS-51-046-02**

Tooth Ext Forceps



**Very Fine Roots 49**

**CS-51-049**

Tooth Ext Forceps



**Roots 51**

**CS-51-051**

Tooth Ext Forceps



**Roots 51A**  
**CS-51-051-01**  
Tooth Ext Forceps



**Roots 51 C**  
**CS-51-051-03**  
Tooth Ext Forceps



**Tooth Ext Forceps**  
**CS-51-057**  
Tooth Ext Forceps



**Tooth Ext Forceps**  
**CS-51-057-1**  
Tooth Ext Forceps



**Tooth Ext Forceps**  
**CS-51-057-02**  
Tooth Ext Forceps



**Third Molars 67**  
**CS-51-067**  
Tooth Ext Forceps



**Third Molars 67 A**  
CS-51-067-01  
Tooth Ext Forceps



**Third Molars Deep Gripping 67 N**  
CS-51-067-02  
Tooth Ext Forceps



**Lower Molars 73**  
CS-51-073  
Tooth Ext Forceps  
Fig -77



**Lower Roots 74**  
CS-51-074  
Tooth Ext Forceps



**Incisors And Roots 74N**  
CS-51-074-06  
Tooth Ext Forceps  
Fig -74N



**Incisors And Roots ,Slender Jaw74XN**  
CS-51-074-07  
Tooth Ext Forceps  
Fig -74XN



**Incisors And Bicuspids**

**CS-51-075**

Tooth Ext Forceps

Fig -75

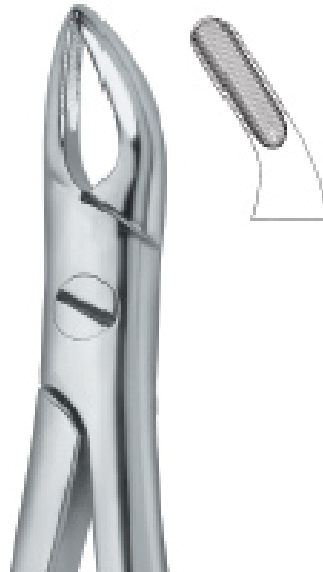

**Upper Roots 76**

**CS-51-076**

Tooth Ext Forceps



**Upper Roots 76N**

**CS-51-076-07**

Tooth Ext Forceps



**Third Molars 79**

**CS-51-079**

Tooth Ext Forceps



**Third Molars 79A**

**CS-51-079-01**

Tooth Ext Forceps

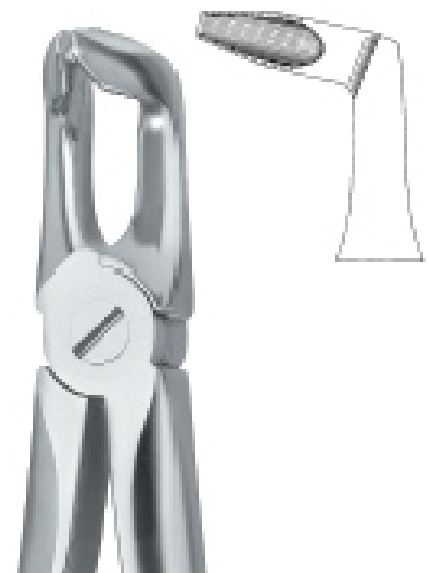

**Third Molars ,Deep Gripping 79N**

**CS-51-079-02**

Tooth Ext Forceps



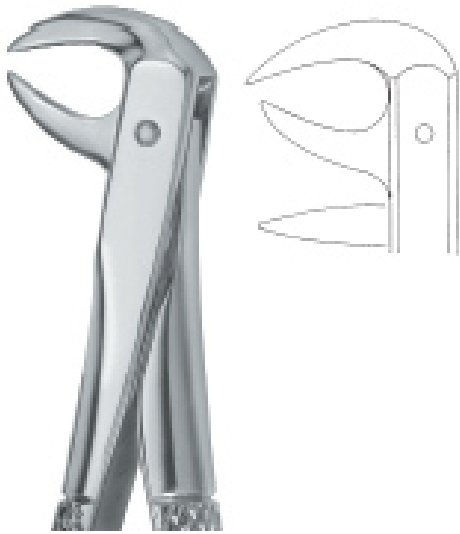

**Molars With Carious Or Broken Caps  
86A**

**CS-51-086-01**  
Tooth Ext Forceps



**Molars With Carious Or Broken Caps  
86B**

**CS-51-086-02**  
Tooth Ext Forceps



**Molars With Carious Or Broken Caps  
86C**

**CS-51-086-03**  
Tooth Ext Forceps



**Tooth Ext Forceps**

**CS-51-097**  
Tooth Ext Forceps



**Very Fine Roots 133**

**CS-51-133**  
Tooth Ext Forceps



**Roots Fragments, Deep Gripping 146**

**CS-51-146**  
Tooth Ext Forceps

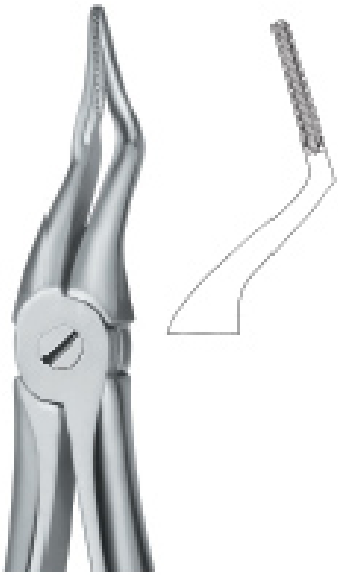

**Tooth Ext Forceps**

**CS-51-151**

Tooth Ext Forceps

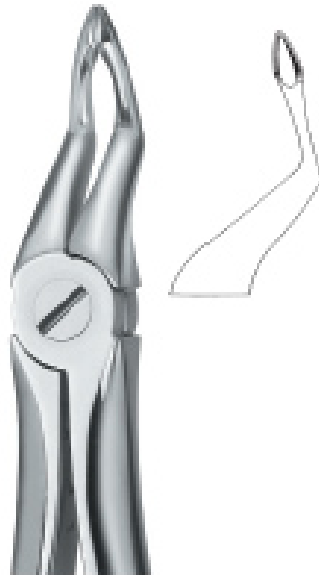

**Tooth Ext Forceps**

**CS-51-153**

Tooth Ext Forceps



**Roots, With Parallel Beak 233**

**CS-51-233**

Tooth Ext Forceps



**Incisors And Bicuspid 1**

**CS-51-301**

Tooth Ext Forceps

Fig -1



**Incisors And Bicuspid 2**

**CS-51-302**

Tooth Ext Forceps

Fig -2



**Bicuspid 7**

**CS-51-307**

Tooth Ext Forceps

Fig -7



**Bicuspid 13**  
**CS-51-313**  
Tooth Ext Forceps  
Fig -13



**Molars 17**  
**CS-51-317**  
Tooth Ext Forceps



**Molars 18**  
**CS-51-318**  
Tooth Ext Forceps



**Molars 22**  
**CS-51-322**  
Tooth Ext Forceps



**Roots 33**  
**CS-51-330**  
Tooth Ext Forceps



**Roots 33**  
**CS-51-333**  
Tooth Ext Forceps



**Roots 51**  
**CS-51-351**  
Tooth Ext Forceps

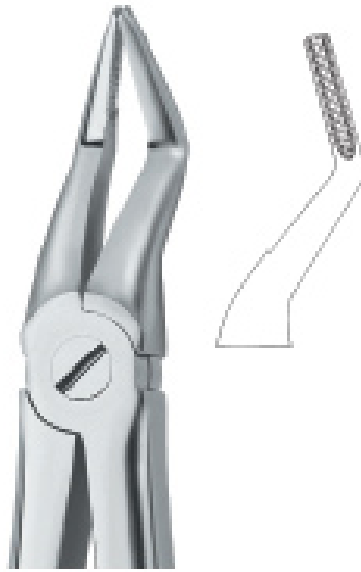

**Roots, Very Fine Beak 51A**  
**CS-51-351-01**  
Tooth Ext Forceps



**Third Molars 67 A**  
**CS-51-367-01**  
Tooth Ext Forceps



**Molars 73**  
**CS-51-373**  
Tooth Ext Forceps



**Incisors And Roots 74**  
**CS-51-374**  
Tooth Ext Forceps  
Fig -74



**Incisors And Roots , With Fine Beak 74N**  
**CS-51-374-01**  
Tooth Ext Forceps  
Fig -74N

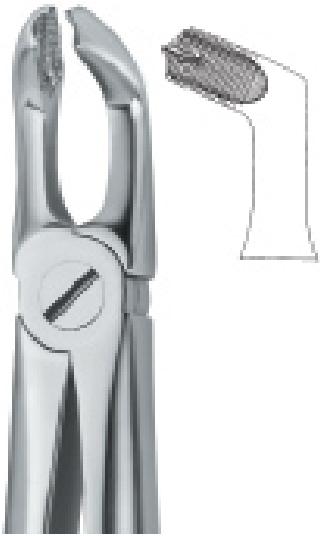

**Third Molars 79**

**CS-51-379**

Tooth Ext Forceps



**Incisors And Cuspids 1**

**CS-51-401**

Tooth Ext Forceps

Fig -1



**Bicuspid 7**

**CS-51-407**

Tooth Ext Forceps

Fig -7



**Incisors And Cuspids 13**

**CS-51-413**

Tooth Ext Forceps

Fig -13



**Molars , Right 17**

**CS-51-417**

Tooth Ext Forceps



**Molars , Left 18**

**CS-51-418**

Tooth Ext Forceps



**Molars 22**

**CS-51-422**

Tooth Ext Forceps



**Roots 33**

**CS-51-433**

Tooth Ext Forceps



**Very Fine Roots 46**

**CS-51-446**

Tooth Ext Forceps

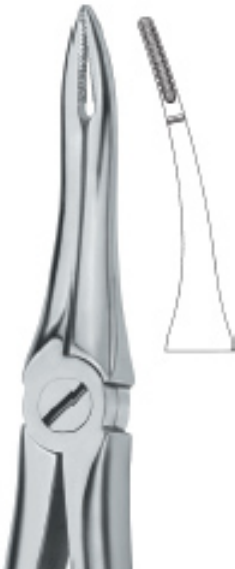

**Very Fine Roots 49**

**CS-51-449**

Tooth Ext Forceps



**Roots 51**

**CS-51-451**

Tooth Ext Forceps



**Roots , With Fine Beak 51A**

**CS-51-451-01**

Tooth Ext Forceps



**Martin Ergo 67A**

**CS-51-467-01**

Tooth Ext Forceps



**Martin Ergo 74N**

**CS-51-474**

Tooth Ext Forceps



**Martin Ergo 79**

**CS-51-479**

Tooth Ext Forceps



**Martin Ergo ,Very Fine Roots 97**

**CS-51-497**



**Bicuspid 13S**

**CS-51-613-09**

Tooth Ext Forceps

Fig -13s



**Molars 22s**

**CS-51-622-09**

Tooth Ext Forceps



**Incisors And Roots 30S**

**CS-51-630-09**

Tooth Ext Forceps

Fig -30S



**Roots 33S**

**CS-51-633-09**

Tooth Ext Forceps



**Incisors And Bicuspid 37**

**CS-51-637**

Tooth Ext Forceps

Fig -37



**Incisors And Cuspids 38**

**CS-51-638**

Tooth Ext Forceps

Fig -38



**Molars 39**

**CS-51-639**

Tooth Ext Forceps



**Molars 39A**

**CS-51-639-01**

Tooth Ext Forceps





**Molars , Left 39L**

**CS-51-639-05**

Tooth Ext Forceps



**Molars , Right 39R**

**CS-51-639-08**

Tooth Ext Forceps



**Molars 40**

**CS-51-640**

Tooth Ext Forceps



**Roots 51S**

**CS-51-651-09**

Tooth Ext Forceps



**Roots 76S**

**CS-51-676-09**

Tooth Ext Forceps



**Molars 3**

**CS-51-703**

Tooth Ext Forceps



**Incisors 5**

**CS-51-705**

Tooth Ext Forceps

Fig -5



**Molars 6**

**CS-51-706**

Tooth Ext Forceps

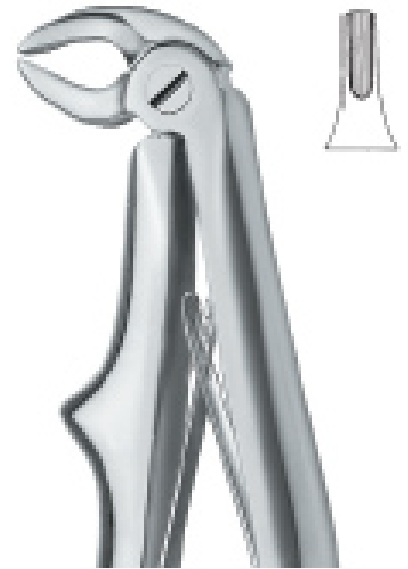

**Roots 7**

**CS-51-707**

Tooth Ext Forceps



**Incisors And Cuspids 137**

**CS-51-737**

Tooth Ext Forceps

Fig -137



**Bicuspid 139**

**CS-51-739**

Tooth Ext Forceps

Fig -139



**Klein, Roots 51S**

**CS-51-751-09**

Tooth Ext Forceps

Fig -51S



**Molars 17SK**

**CS-51-817-09**

Tooth Ext Forceps



**Molars 23SK**

**CS-51-823-09**

Tooth Ext Forceps



**Teeth And Roots ,Universal 150SK**

**CS-51-850-09**

Tooth Ext Forceps



**Teeth And Roots , Universal 151Sk**

**CS-51-851-09**

Tooth Ext Forceps



**Incisors And Bicuspid 1**

**CS-52-001**

Tooth Ext Forceps Amr

18.5cm



**Henahan Incisors**

**CS-52-001-01**

Tooth Ext Forceps Amr



**Molars And Third Molars 10S**

**CS-52-010-09**

Tooth Ext Forceps Amr

Fig -10s



**Molars 15**

**CS-52-015**

Tooth Ext Forceps Amr



**Molars 16**

**CS-52-016**

Tooth Ext Forceps Amr

Fig -16



**Molars, Slender Jaw**

**CS-52-016-09**

Tooth Ext Forceps Amr

Fig -16



**Molars 17**

**CS-52-017**

Tooth Ext Forceps Amr

Fig -17

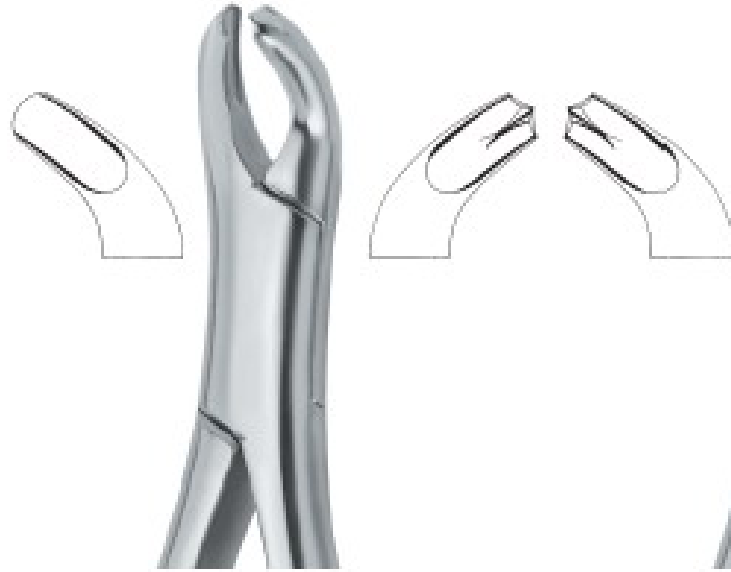

**Harris Molars , Left 18L**

**CS-52-018-05**

Tooth Ext Forceps Amr

Fig -18L



**Harris Molars , Right 18R**

**CS-52-018-08**

Tooth Ext Forceps Amr

Fig -18R



**Molars**

**CS-52-023**

Tooth Ext Forceps Amr

Fig -23



**Parmlly Molars And Bicuspid 32**

**CS-52-032**

Tooth Ext Forceps Amr

Fig -32



**Parmlly Molars And Bicuspid , Roots 32A**

**CS-52-032-01**

Tooth Ext Forceps Amr

Fig -32L



**Molars , Left 53L**

**CS-52-053-05**

Tooth Ext Forceps Amr  
18.5cm



**Molars , Right 53R**

**CS-52-053-08**

Tooth Ext Forceps Amr  
Fig -53R



**Teeth And Roots,Universal Also For Children 62**

**CS-**

Tooth Ext Forceps Amr  
Fig -62



**Incisors And Roots 65**

**CS-52-065**

Tooth Ext Forceps Amr  
Fig -65



**Tomes Roots Fragments And Small Roots 69**

**CS-52-069**

Tooth Ext Forceps Amr



**Nevius Molars , Left 88L**

**CS-52-088-05**

Tooth Ext Forceps Amr  
Fig -88L



**Nevius Molars , Right 88R**

**CS-52-088-08**

Tooth Ext Forceps Amr

Fig -88R



**Cryer Bicuspid, Incisors And  
Roots 150**

**CS-52-150**

Tooth Ext Forceps Amr



**Cryer Bicuspid, Incisors And  
Roots 150A**

**CS-52-150-01**

Tooth Ext Forceps Amr

Fig -150A



**Bicuspid And Incisors , Roots 150X**

**CS-52-150-02**

Tooth Ext Forceps Amr

Fig -150X



**Bicuspid And Incisors, Roots  
150AS**

**CS-52-150-08**

Tooth Ext Forceps Amr

fig -150 A



**Cryer Bicuspid And Incisors ,  
Roots 150S**

**CS-52-150-09**

Tooth Ext Forceps Amr

Fig -150S



**Cryer Bicuspid , Incisors And Roots  
151**

**CS-52-151**

Tooth Ext Forceps Amr

Fig -151



**Cryer Bicuspid , Incisors And Roots  
151A**

**CS-52-151-01**

Tooth Ext Forceps Amr

Fig -151A



**Cryer Bicuspid , Incisors And Roots  
151X**

**CS-52-151-02**

Tooth Ext Forceps Amr

Fig 151X



**Bicuspid And Incisors , Roots 151AS**

**CS-52-151-08**

Tooth Ext Forceps Amr

Fig -151 AS



**Cryer Teeth And Roots , Universal  
151S**

**CS-52-151-09**

Tooth Ext Forceps Amr

Fig -151S



**Third Molars 222**

**CS-52-222**

Tooth Ext Forceps Amr

Fig -222





**Root Fragments And Universal 501**

**CS-52-501**

Tooth Ext Forceps Amr

Fig -502



**Witzel Root Fragments And Universal 502**

**CS-52-502**

Tooth Ext Forceps Amr



**Seldin 1L**  
**CS-53-001-05**  
Root Elevators



**Seldin 1R**  
**CS-53-001-08**  
Root Elevator



**Seldin 2**  
**CS-53-002-00**  
Root Elevators

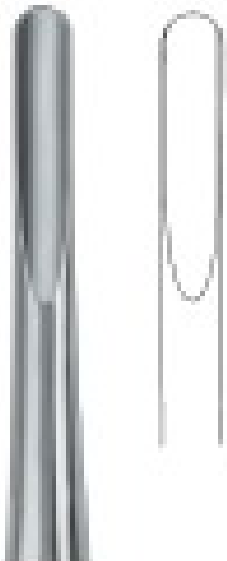

**Seldin**  
**CS-53-003-00**  
Root Elevators

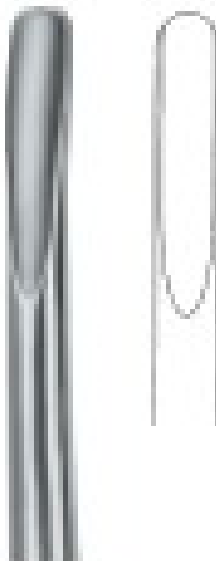

**Cryer**  
**CS-53-003-01**  
Root Elevators



**Seldin 4L**  
**CS-53-004-05**  
Root Elevators



**Seldin 4R**  
**CS-53-004-08**  
Root Elevators



**Crane Pick 6**  
**CS-53-006-00**  
Root Elevators



**Miller 1**  
**CS-53-008-00**  
Root Elevators



**Miller 2**  
**CS-53-009-00**  
Root Elevators



**Miller-Apexo**  
**CS-53-010-00**  
Root Elevators



**Miller-Apexo**  
**CS-53-011-00**  
Root Elevators



**Cryer**  
**CS-53-012-00**  
Root Elevators



**Cryer**  
**CS-53-027-00**  
Root Elevators



**Cryer 28**  
**CS-028-00**  
Root Elevators

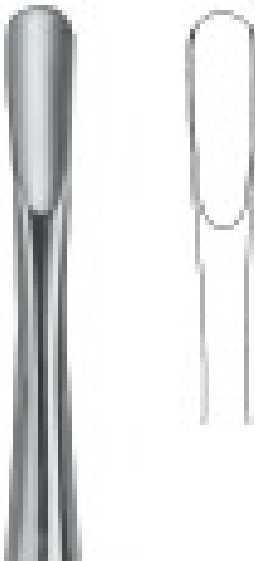

**Seldin 34**  
**CS-53-034-00**  
Root Elevators

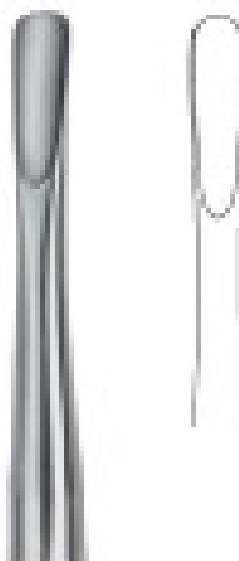

**Seldin 34S**  
**CS-53-034-09**  
Root Elevators



**Cryer 27S**  
**CS-53-039-00**  
Root Elevators



**Cryer 28S**  
CS-53-040-00  
Root Elevators

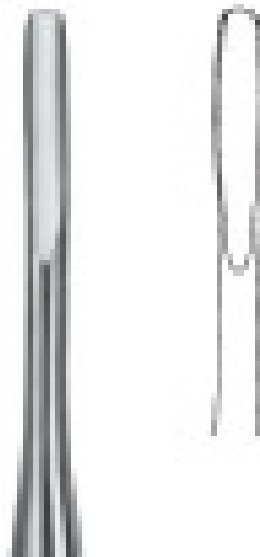

**Flohr**  
CS-53-046-00  
Root Elevators



**Barry 50**  
CS-53-050-00  
Root Elevators  
Fig -50



**Barry 51**  
CS-53-051-00  
Root Elevators  
Fig -51



**Lindo Levian 1**  
CS-53-200-01  
Root Elevators

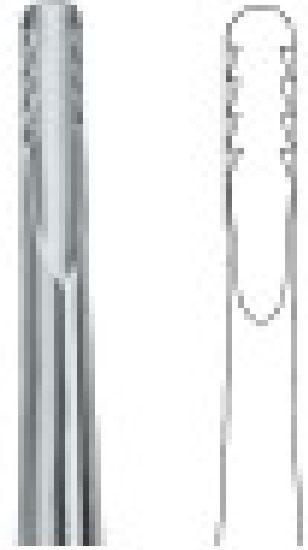

**Lindo Levian 3**  
CS-53-200-03



**Howard-Apexo # 1**

**CS-53-204-00**  
Root Elevators

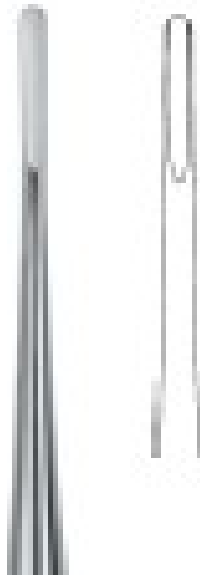

**Root Elevators**

**CS-53-204-01**  
Root Elevators

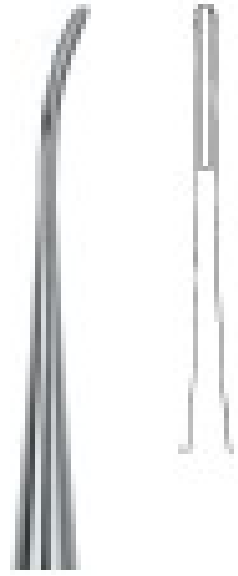

**Root Elevators**

**CS-53-205-00**

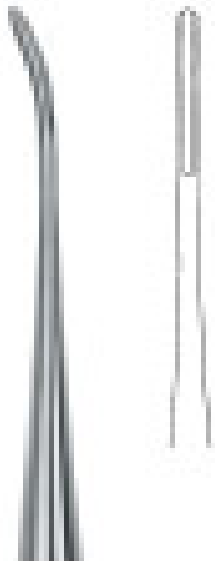

**Root Elevators**

**CS-53-205-01**  
Root Elevators



**Bein 1**

**CS-53-220-01**  
Root Elevator

Fig -1

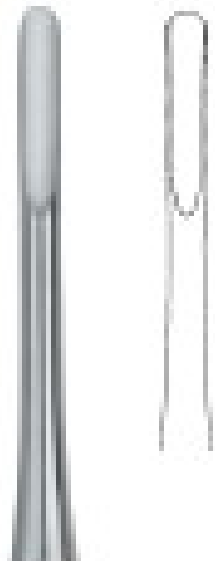

**Bein 2**

**CS-53-220-02**  
Root Elevator

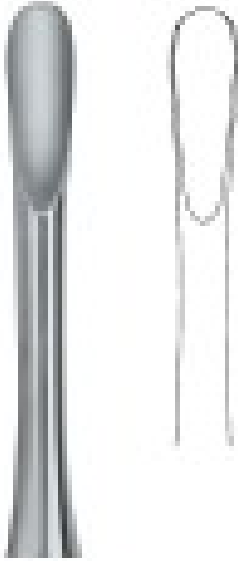

**Bein 4**  
CS-53-220-04

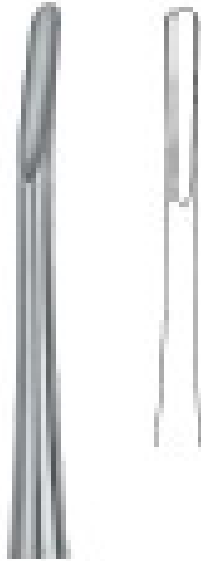

**Bein 1A**  
CS-53-221-01



**Bein 2A**  
CS-53-221-02

Fig -1A

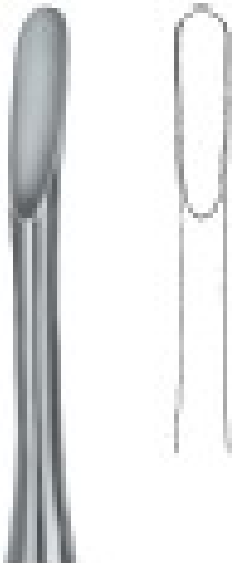

**Bein 3A**  
CS-53-221-03

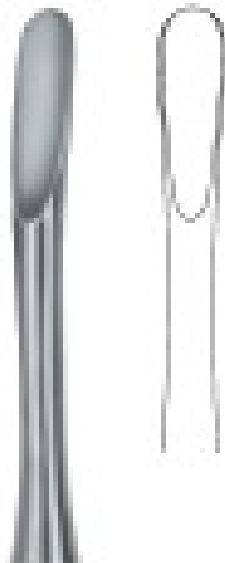

**Bein 4A**  
CS-53-221-04



**Apical 1**  
CS-53-222-01

Fig -1

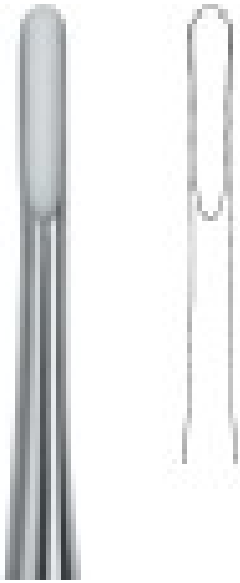

**Apical 2**  
CS-53-222-02

Fig -2

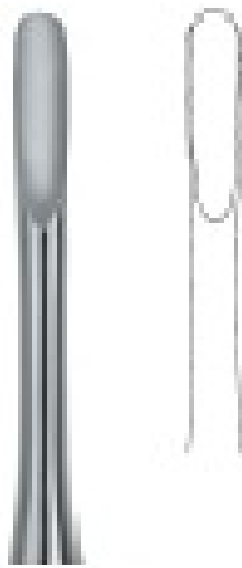

**Apical 3**  
CS-53-222-03

Fig -3



**Apical 4**  
CS-53-222-04

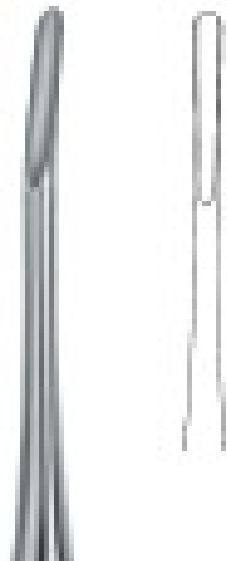

**Apical 1A**  
CS-53-223-01

Fig -1A



**Apical 2A**  
CS-53-223-02

Fig -2



**Apical 3A**  
CS-53-223-03





**Apical 4A**  
CS-53-223-04

Fig -4A



**Apical 301**  
CS-53-301-00

Fig -301

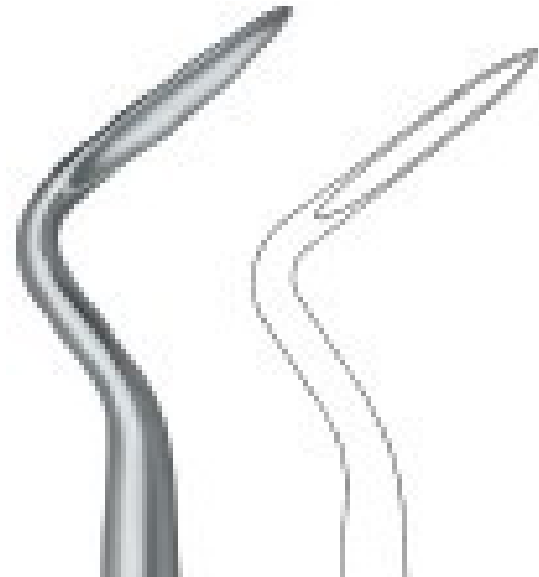

**Apical 302**  
CS-53-302-00  
Root Elevators



**Apical-Flohr**  
CS-53-303-00  
Root Elevators

Fig -303

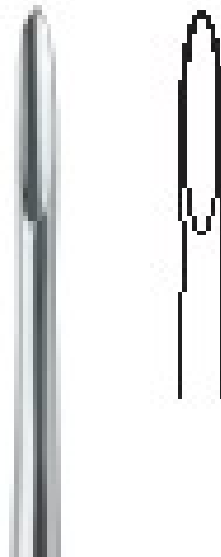

**Apical 304**  
CS-53-304-00  
Root Elevators

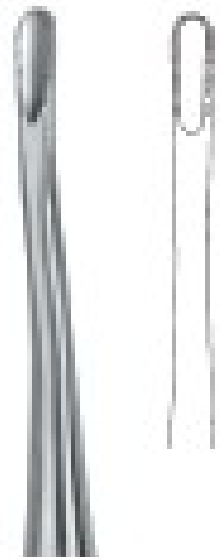

**Apical 46R**  
CS-53-311-00  
Root Elevators



**Coleman**  
**CS-53-405-01**  
Root Elevators



**Coleman 2L**  
**CS-53-405-02**  
Root Elevators



**Coleman 3R**  
**CS-53-405-03**  
Root Elevators

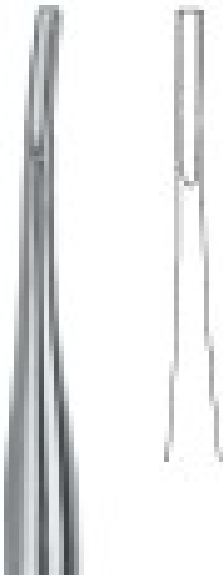

**Coupland Bone Chisels 1**  
**CS-53-415-01**  
Root Elevators

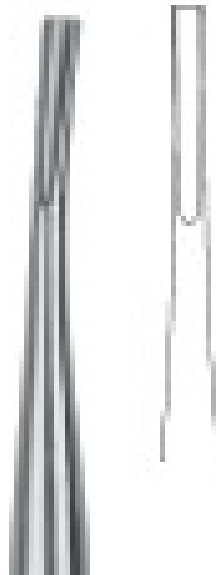

**Coupland Bone Chisels 2**  
**CS-53-415-02**  
Root Elevators

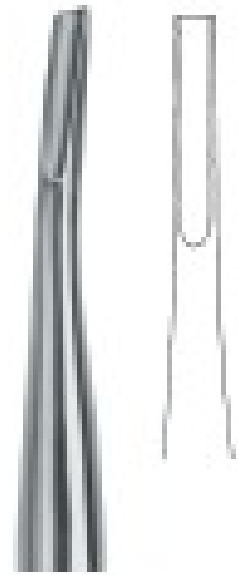

**Coupland Bone Chisels 3**  
**CS-53-415-03**  
Root Elevators



**Friedman 1**  
CS-53-505-01  
Root Elevators



**Friedman 2L**  
CS-53-505-02  
Root Elevators



**Friedman 2R**  
CS-53-505-03  
Root Elevators



**Hylin 1**  
CS-53-508-01  
Root Elevators

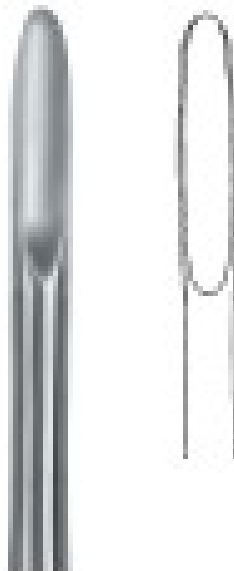

**Hylin 2**  
CS-53-508-02  
Root Elevators



**Hylin 3L**  
CS-53-508-03  
Root Elevators

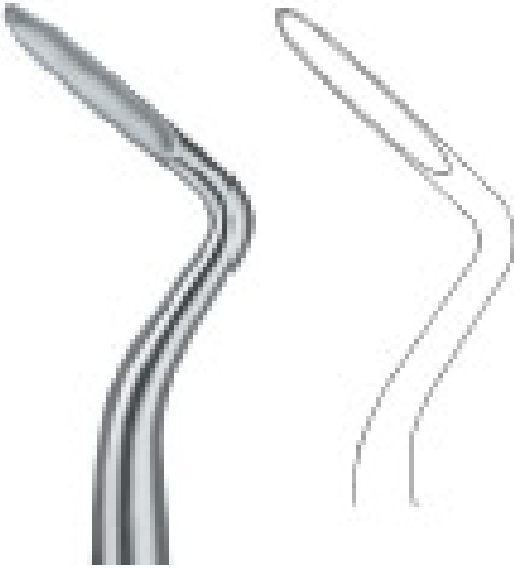

**Hylin 4R**  
CS-53-508-04  
Root Elevators



**Bein 0**  
CS-53-511-00  
Root Elevators

Fig-0

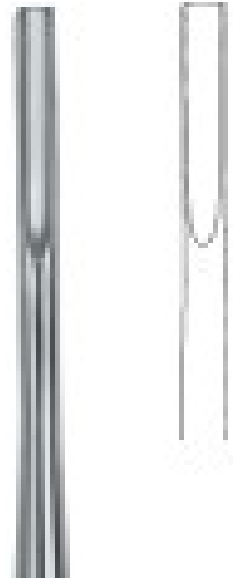

**Bein 1**  
CS-53-511-01  
Root Elevators

Fig-1

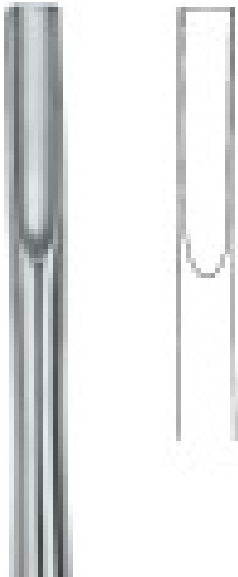

**Bein 2**  
CS-53-511-02  
Root Elevators

Fig-2

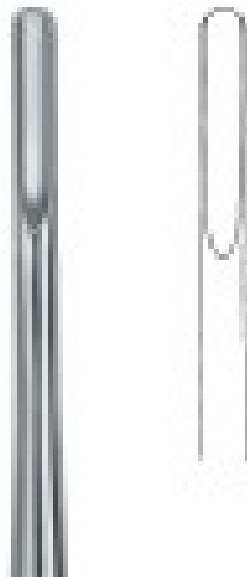

**Bein 1**  
CS-53-512-01  
Root Elevators

Fig-1

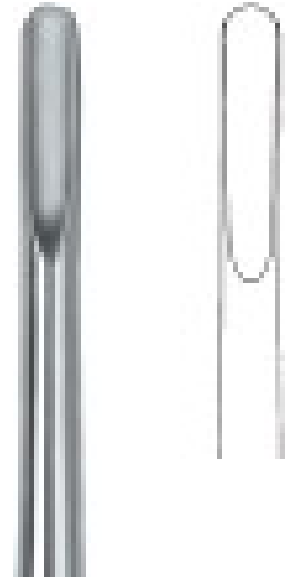

**Bein 2**  
CS-53-512-02  
Root Elevators



**Bein 0**  
**CS-53-513-00**  
Root Elevators  
Fig -0

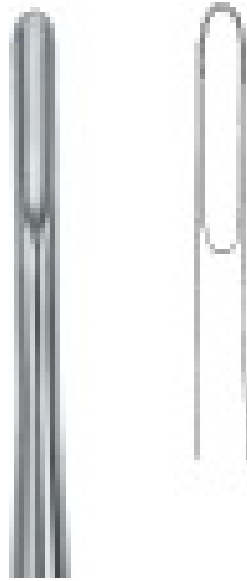

**Bein 1**  
**CS-53-513-01**  
Root Elevators  
Fig -1

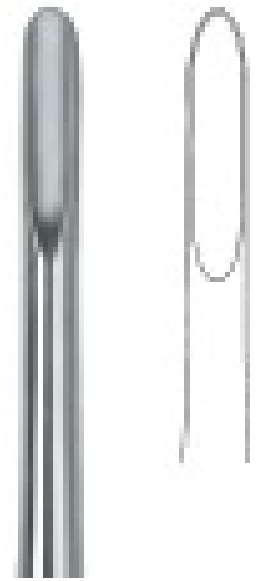

**Bein 2**  
**CS-53-513-02**  
Root Elevators



**Bein 0A**  
**CS-53-514-00**  
Root Elevators  
Fig -0A

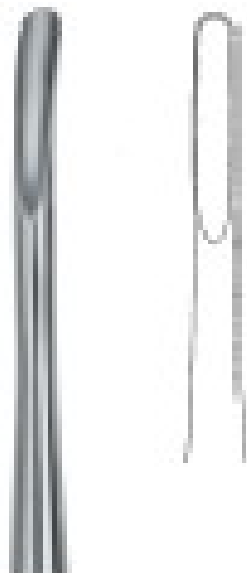

**Bein 1A**  
**CS-53-514-01**  
Root Elevators  
Fig -1A

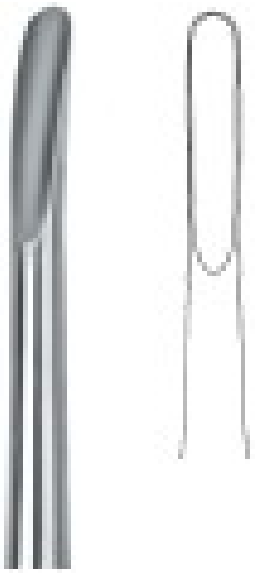

**Bein 2A**  
**CS-53-514-02**  
Root Elevators



**Bein 0A**  
CS-53-515-00  
Root Elevators  
Fig -0A

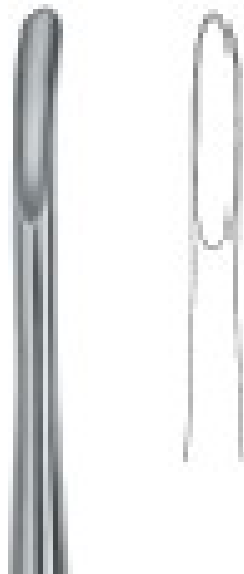

**Bein 1A**  
CS-53-515-01  
Root Elevators  
Fig -1A

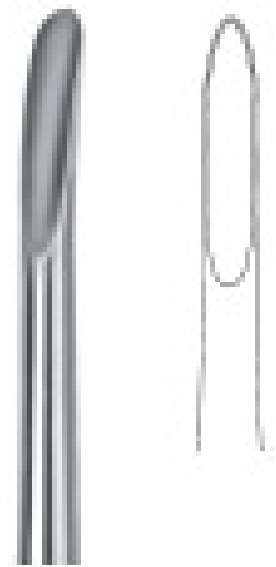

**Bein 2A**  
CS-53-515-02  
Root Elevators



**W.F. Barry 320L**  
CS-53-533-20  
Root Elevators



**W.F. Barry 321R**  
CS-53-533-21  
Root Elevators



**Barry 322**  
CS-53-533-22  
Root Elevators  
Fig -322



**Barry 323**

**CS-53-533-23**

Root Elevators

Fig -323



**W.F. Barry 370R**

**CS-53-533-70**

Root Elevators



**W.F. Barry 371R**

**CS-53-533-71**

Root Elevators



**Winter 11L**

**CS-53-551-05**

Root Elevators



**Winter 11R**

**CS-53-551-08**

Root Elevators



**Winter 13L**

**CS-53-553-05**

Root Elevators



**Winter 13R**  
**CS-53-553-08**  
Root Elevators



**Winter 14L**  
**CS-53-554-05**  
Root Elevators



**Winter 14R**  
**CS-53-554-08**  
Root Elevators



**Lecluse 1**  
**CS-53-561-01**  
Root Elevators



**Pott 1**  
**CS-53-567-01**  
Root Elevators



**Pott 2**  
**CS-53-567-02**  
Root Elevators





**Krallenheber 1L**  
CS-53-571-01  
Root Elevators



**Krallenheber 2R**  
CS-53-571-02  
Root Elevators



**Warwick-James 1**  
CS-53-576-01  
Root Elevators

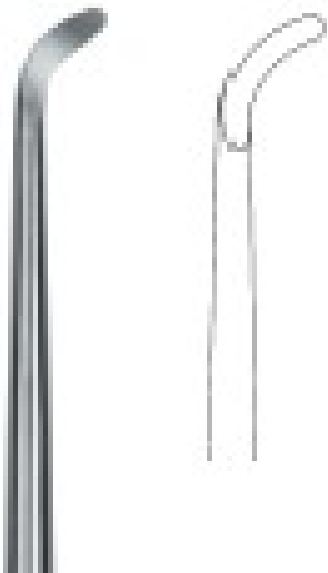

**Warwick-James 2L**  
CS-53-576-02  
Root Elevators



**Warwick-James 3R**  
CS-53-576-03  
Root Elevators



**Chompret 1**  
CS-53-577-01  
Root Elevators



**Chompret 2**  
CS-53-577-02  
Root Elevators

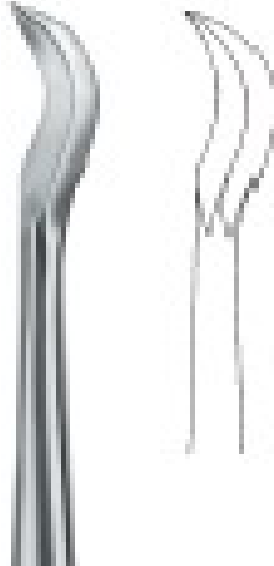

**Chompret 3**  
CS-53-577-03  
Root Elevators



**Heidebrink 1**  
CS-53-582-01  
Root Elevators



**Heidebrink 2**  
CS-53-582-02  
Root Elevators



**Heidebrink 3**  
CS-53-582-03  
Root Elevators



**West 1**  
CS-53-584-01  
Root Elevators

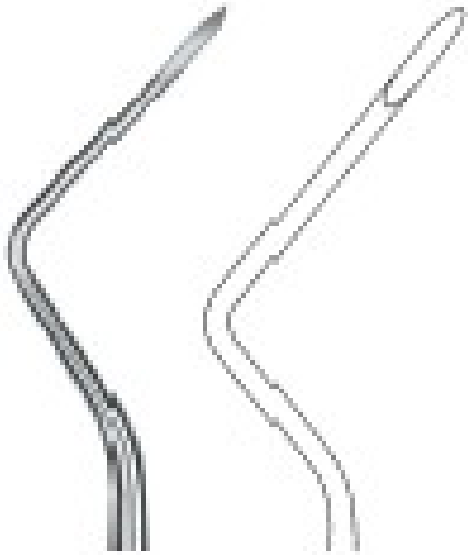

**West 2**

**CS-53-584-02**

Root Elevators

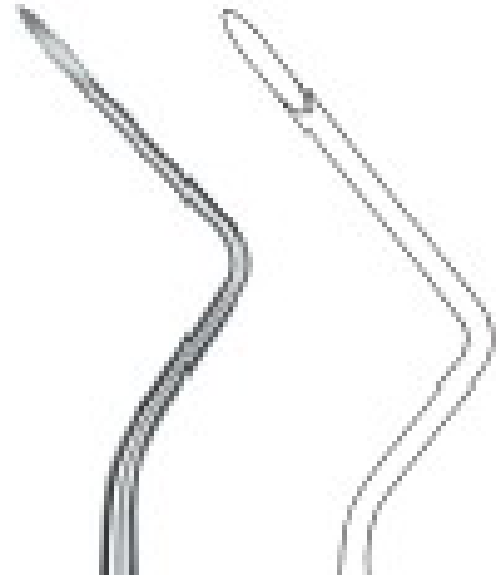

**West 3**

**CS-53-584-03**

Root Elevators



**Bone Rongeur**

**CS-54-101**

Bone Holding Forceps

7"185mm



**Bone Rongeur**

**CS-54-102**

Bone Holding Forceps

7"185mm



**Bone Rongeur**

**CS-54-103**

Bone Holding Forceps

8"200mm



**Bone Rongeur**

**CS-54-104**

Bone Holding Forceps

8"215mm



**Bone Rongeur**

**CS-54-105**

Bone Rongeur

145mm5"



**Friedman-Micro 6"**

**CS-54-106**

Bone Rongeurs

5"150mm



**Friedman-Micro 5"**

**CS-54-107**  
Bone Rongeurs  
145mm5"



**Bone Rongeur**

**CS-54-108**  
Bone Rongeur  
5"140mm



**LUER 6"**

**CS-54-109**  
Bone Rongeurs  
150mm6"



**LUER 6"**

**CS-54-110**  
Bone Rongeurs  
150mm6"



**2A-MEAD, SQUARE TIPS 5"**

**CS-54-111**  
Bone Rongeur  
145mm5"



**BLUMENTHAL 6"**

**CS-54-112**  
Bone Rongeurs  
6"155mm



**BLUMENTHAL 45° 6"**

**CS-54-113**  
Bone Rongeur  
150mm6"



**Bone Rongeur 7"**

**CS-54-114**  
Bone Rongeur  
7"175mm



**Bone Rongeur**

**CS-54-115**  
Bone Rongeur  
5"170mm



**BEYER 7"**

**CS-54-116**  
Bone Rongeur  
7"180mm



**BANE-HEARTMANN 7"**

**CS-54-118**  
Bone Rongeur  
175mm7"



**BEYER DOUBLE-ACTION 7"**

**CS-54-119**  
Bone Rongeur  
7"180mm



**ZUFAL-JANSEN 7"**

**CS-54-120**  
Bone Rongeur  
7"180mm



**Bone Rongeur**

**CS-54-121**  
Bone Rongeur  
130mm5.5"



**Bone Rongeur**

**CS-54-122**  
Bone Rongeur  
130mm5.5"



**Cleveland 5"**

**CS-54-123**  
Bone Cutting Forceps  
5"130mm



**Bone Rongeur**

**CS-54-124**  
Bone Cutting Forceps  
5"160mm



Fig. 1  
Polokoff

**Polokoff**  
**CS-55-101**  
Bone Files  
Fig -1



Fig. 33

**Bone Files**  
**CS-55-102**  
Bone Files  
Fig -33

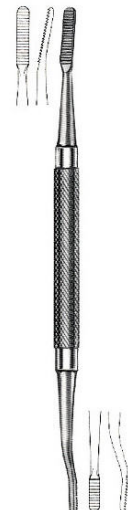

Fig. 64  
Miler

**Miler**  
**CS-55-103**  
Bone Files  
Fig -64



Fig. 45  
Miler

**Miler**  
**CS-55-104**  
Bone Files  
Fig -45



Fig. 10

**Bone Files**  
**CS-55-105**  
Bone Files  
Fig -10



Fig. 1  
Wahl

**Wahl**  
**CS-55-106**  
Bone Files  
Fig -1





**Wahl**

**CS-55-107**

Bone Files

Fig -2



**Bone Files**

**CS-55-108**

Bone Files

Fig -12CA

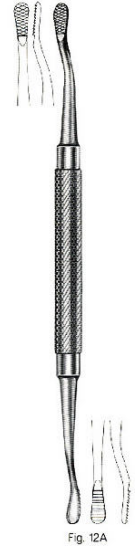

**Bone Files**

**CS-55-109**

Bone Files

Fig -12A

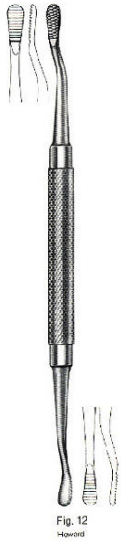

**Howard**

**CS-55-110**

Bone Files

Fig -12



Fig 1  
Hemingway

**Hemingway**

**CS-56-101**

Bone Curettes

Fig -1



Fig. 2  
Hemingway

**Hemingway**

**CS-56-102**

Hemingway

Fig -2



Fig 3  
Hemingway

**Hemingway**

**CS-56-103**

Bone Curettes

Fig -3



Fig 4  
Hemingway

**Hemingway**

**CS-56-104**

Bone Curettes

Fig -4



Fig. 86  
Lucas

**Lucas**

**CS-56-105**

Bone Curettes

Fig -86



Fig. 87  
Lucas

**Lucas**

**CS-56-107**

Bone Curettes

Fig -87



Fig. 88  
Lucas

**Lucas**  
**CS-56-108**  
Bone Curettes  
Fig -88



Fig. 1  
Hemingway

**Hemingway**  
**CS-56-109**  
Bone Curettes  
Fig -1



Fig. 2  
Hemingway

**Hemingway**  
**CS-56-110**  
Bone Curettes  
Fig -2



Fig. 3  
Hemingway

**Hemingway**  
**CS-56-111**  
Bone Curettes



Fig. 4  
Hemingway

**Hemingway**  
**CS-56-112**  
Bone Curettes  
Fig -4



Fig. 85  
Lucas

**Lucas**  
**CS-56-113**  
Bone Curettes  
Fig -85



Fig. 86  
Lucas

**Lucas**

**CS-56-114**

Bone Curettes

Fig -86



Fig. 87  
Lucas

**Lucas**

**CS-56-115**

Bone Curettes

Fig -87



Fig. 88  
Lucas

**Lucas**

**CS-56-116**

Bone Curettes

Fig -83



**Cotton & Dressing Tweezers**

**CS-57-101**  
Tooth Tweezers  
5"130mm



**College Tweezer**

**CS-57-102**  
Cotton & Dressing Tweezers  
5"130mm



**College Tweezer Smooth Plan Handle**

**CS-57-103**  
Cotton & Dressing Tweezers  
150mm6"



**Meriam Tweezers**

**CS-57-104**  
Cotton & Dressing Tweezers  
6"160mm



**College Tweezer**

**CS-57-105**  
Cotton & Dressing Tweezers  
6"160mm



**Meriam Tweezers**

**CS-57-106**  
Cotton & Dressing Tweezers  
6"160mm



**Meriam Tweezers**

**CS-57-107**

Cotton & Dressing Tweezers

6"160mm



**College Tweezer**

**CS-57-108**

Cotton & Dressing Tweezers

150mm6"



**College Tweezer**

**CS-57-109**

Cotton & Dressing Tweezers

150mm6"



**Self Locking Tweezer Serr.**

**CS-57-110**

Cotton & Dressing Tweezers

6"160mm



**College Tweezer**

**CS-57-111**

Cotton & Dressing Tweezers

6"160mm



**College Tweezer**

**CS-57-112**

Cotton & Dressing Tweezers

150mm6"



**Perry Tweezer**

**CS-57-113**

Cotton & Dressing Tweezers

130mm



**Cotton & Dressing Tweezers**

**CS-57-114**

Cotton & Dressing Tweezers

6"160mm



**Flagg Tweezer Smooth**

**CS-57-115**

Cotton & Dressing Tweezers

150mm6"



**Flagg Tweezer Serrated**

**CS-57-116**

Cotton & Dressing Tweezers

5"160mm



**Cotton & Dressing Tweezers**

**CS-57-117**

Cotton & Dressing Tweezers

5"150mm



**Cotton & Dressing Tweezers**

**CS-57-118**

Tooth Tweezers

6"160mm



**Cotton & Dressing Tweezers**

**CS-57-119**

Tooth Tweezers

6"160mm



**Self Locking Tweezer Smooth**

**CS-57-120**

Cotton & Dressing Tweezers

150mm6"



**Suture Forceps**

**CS-57-121**

Cotton & Dressing Tweezers

150mm6"





**Rubber Dam Punch Ivory**

**CS-58-101**

Rubber-Dam Instruments

6"160mm



**Anisworth**

**CS-58-102**

Rubber-Dam Instruments

6"160mm



**Brewer**

**CS-58-103**

Rubber-Dam Instruments

6"170mm



**Palmer**

**CS-58-104**

Rubber-Dam Instruments

7"175mm



**Crile-Murray**

**CS-60-101**

Needle Holders

5"130mm



**Mayo-Hegar**

**CS-60-102**

Needle Holders

7"160mm



**Crile-Murray**

**CS-60-103**

Needle Holders

150mm6"



**Mayo-Hegar**

**CS-60-104**

Needle Holders

150mm6"



**Mayo-Hegar**

**CS-60-105**

Needle Holders

7"180mm



**Mayo-Hegar**

**CS-60-106**

Needle Holders

8"200mm



**Olsen-Hegar**

**CS-60-107**

Needle Holders

5"140mm



**Gillies**

**CS-60-108**

Needle Holders

7"150mm



**Boynton**

**CS-60-109**

Needle Holders

5"125 mm



**Mathieu**

**CS-60-110**

Needle Holders

7"170mm



**Mathieu**

**CS-60-111**

Needle Holders

8"200mm



**Crile**

**CS-60-112**

Needle Holders

150mm6"



**Toennis**  
**CS-60-113**  
Needle Holders



**Mayo-Hegar**  
**CS-60-114**  
Needle Holders  
7"165mm



**Mayo-Hegar**  
**CS-60-115**  
Needle Holders  
8"210mm



**Mayo-Hegar**  
**CS-60-116**  
Needle Holders  
165mm



**Mayo-Hegar**  
**CS-60-117**  
Needle Holders  
6"165mm



**Debakey**  
**CS-60-118**  
Needle Holders  
5"160mm



**Debakey**  
**CS-60-119**  
Needle Holders  
7"



**Ryder**  
**CS-60-120**  
Needle Holders



**Ryder**  
**CS-75-121**  
Needle Holders



**Ryder 7 CARB-N-SERT Jaws**  
**CS-60-122**  
Needle Holders



**Bozemann 5**  
**CS-60-123**  
Needle Holders  
5"135mm



**Olsen-Hegar CARB-N-SERT Jaws**  
**CS-60-124**  
Needle Holders



**Olsen-Hegar CARB-N-SERT Jaws**

**CS-60-125**  
Needle Holders



**Olsen-Hegar CARB-N-SERT Jaws**

**CS-60-126**  
Needle Holders



**Olsen-Hegar CARB-N-SERT Jaws**

**CS-60-127**  
Needle Holders



**Needle Holders**

**CS-60-128**  
Needle Holders  
7"185mm



**Needle Holders**

**CS-60-129**  
Needle Holders  
7"185mm



**Ryder 8 CARB-N-SERT Jaws**

**CS-60-130**  
Needle Holders



**Needle Holders**

**CS-60-131**

Needle Holders

8"200mm



**Mathieu 5**

**CS-60-132**

Needle Holders

5"140mm



**Mathieu 6**

**CS-60-133**

Needle Holders

5"170mm



**Mathieu 8**

**CS-60-134**

Needle Holders

8"200mm



**Mathieu 5**

**CS-60-135**

Needle Holders

5"140mm



**Mathieu 6**

**CS-60-136**

Needle Holders

6"170mm



**Mathieu 8**  
**CS-60-137**  
Needle Holders  
8"200mm



**Mathieu 7**  
**CS-60-138**  
Needle Holders  
7"195mm



**Mathieu CARB-N-SERT Jaws**  
**CS-60-139**  
Needle Holders  
8"205mm





**LISTER Bandage Scissors**

**CS-61-101**  
GUM Scissors  
Extra fine



**LISTER Bandage Scissors**

**CS-61-102**  
Gum Scissors  
Extra fine



**LISTER Bandage Scissors**

**CS-61-103**  
Gum Scissors  
Extra fine



**KNOWLES Bandage Scissors**

**CS-61-104**  
Gum Scissors  
Straight



**HEATH Suture Scissors**

**CS-61-105**  
Gum Scissors Serrated blade  
6-1/8" (15.6cm)



**SPENCER Stitch Scissors**

**CS-61-106**  
Gum Scissors  
Delicate



**SHORTBENT Stitch Scissors**

**CS-61-107**

Gum Scissors Curved delicate



**LITTAUER JR. Stitch Scissors**

**CS-61-108**

Gum Scissors



**NORTHBENT Stitch Scissors**

**CS-61-109**

Gum Scissors Curved light pattern



**LITTAUER Stitch Scissors**

**CS-61-110**

Gum Scissors Standard pattern



**LONG Oral Surgery Stitch Scissors**

**CS-61-111**

Gum Scissors



**MILTEX Stitch Scissors**

**CS-61-112**

Gum Scissors Angled delicate



**REEH Stitch Scissors**

**CS-61-113**

Gum Scissors

Sharp tips small hook on 1 blade ribbon type



**MILTEX Stitch Scissors**

**CS-61-114**

Gum Scissors Curved sharp pointed tips ribbon type



**MILTEX Stitch Scissors**

**CS-61-115**

Gum Scissors Curved sharp pointed tips ribbon type



**VANTAGE Crown Scissors**

**CS-61-116**

Gum Scissors Collar curved



**VANTAGE Collar**

**CS-61-117**

Gum Scissors Crown Scissors straight

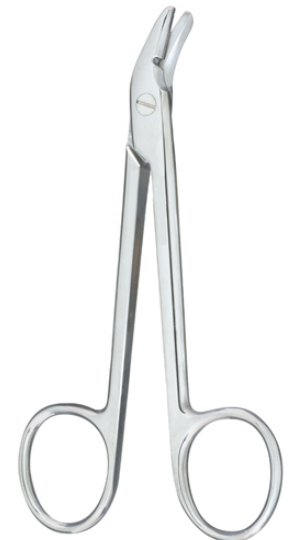

**MILTEX Wire Cutting Scissors**

**CS-61-118**

Gum Scissors Angled to side one serrated blade



**MILTEX Wire Cutting Scissors**

**CS-61-119**

Gum Scissors Angled to side, one serrated blade, Carb-N-Sert inserts



**Standard Pattern Operating Scissors**

**CS-61-120**

Gum Scissors Straight sharp-sharp points



**Standard Pattern Operating Scissors**

**CS-61-121**

Gum Scissors Straight sharp-sharp points



**Standard Pattern Operating Scissors**

**CS-61-122**

Gum Scissors Straight sharp-blunt points



**Standard Pattern Operating Scissors**

**CS-61-123**

Gum Scissors Straight sharp-blunt points



**Standard Pattern Operating Scissors**

**CS-61-124**

Gum Scissors Straight sharp-blunt points



**Standard Pattern Operating Scissors**

**CS-61-125**

Gum Scissors Curved sharp/sharp points



**Standard Pattern Operating Scissors**

**CS-61-126**

Gum Scissors Curved sharp/sharp points



**Standard Pattern Operating Scissors**

**CS-61-127**

Gum Scissors Curved



**Standard Pattern Operating Scissors**

**CS-61-128**

Gum Scissors Curved, sharp-blunt points



**MAYO Dissecting Scissors**

**CS-61-129**

Gum Scissors Straight, standard beveled blades



**MAYO Dissecting Scissors**

**CS-61-130**

Gum Scissors Straight, standard beveled blades



**MAYO Dissecting Scissors**

**CS-61-131**

Gum Scissors Curved, standard beveled blades



**MAYO Dissecting Scissors**

**CS-61-132**

Gum Scissors Curved, standard beveled blades



**Delicate Pattern METZENBAUM Scissors**

**CS-61-133**

Gum Scissors Straight, blunt points  
5-1/2" (14cm)



**Delicate Pattern METZENBAUM Scissors**

**CS-61-134**

Gum Scissors Straight, sharp points  
5-1/2" (14cm)



**Standard Pattern METZENBAUM Scissors**

**CS-61-135**

Gum Scissors  
Curved, blunt points



**Standard Pattern METZENBAUM Scissors**

**CS-61-136**

Gum Scissors  
Curved, blunt points



**Delicate Pattern METZENBAUM Scissors**

**CS-61-137**

Gum Scissors Curved, blunt points

5-1/2" (14cm)



**Delicate Pattern METZENBAUM Scissors**

**CS-61-138**

Gum Scissors Curved, sharp points

5-1/2" (14cm)



**KELLY Scissors**

**CS-61-139**

Gum Scissors

Straight, sharp points



**KELLY Scissors**

**CS-61-140**

Gum Scissors

Curved, sharp points



**KELLY Scissors**

**CS-61-141**

Gum Scissors

Sharp points, angled on side



**KAYE Blepharoplasty And Dissecting Scissors**

**CS-61-142**

Gum Scissors One serrated blade, ribbon type

4-1/2" (10.58cm)



**DEAN Dissecting Scissors**

**CS-61-143**

Gum Scissors Blades angled on flat, one serrated blade  
6-3/4" (17.5cm)



**KAYE Dissecting Scissors**

**CS-61-144**

Gum Scissors Curved, one serrated blade  
4-17/32" (11.5 cm)



**WAGNER Plastic Surgery Scissors**

**CS-61-145**

Gum Scissors  
Straight, sharp-sharp points, serrated blade



**WAGNER Plastic Surgery Scissors**

**CS-61-146**

Gum Scissors  
Straight, sharp-sharp points, serrated blade



**WAGNER Plastic Surgery Scissors**

**CS-61-147**

Gum Scissors  
Straight, sharp-blunt points



**WAGNER Plastic Surgery Scissors**

**CS-61-148**

Gum Scissors  
Straight, sharp-blunt points, serrated blade





**WAGNER Plastic Surgery Scissors**

**CS-61-149**

Gum Scissors

Straight, blunt-blunt points



**WAGNER Plastic Surgery Scissors**

**CS-61-150**

Gum Scissors

Straight, blunt-blunt points, serrated blade



**WAGNER Plastic Surgery Scissors**

**CS-61-151**

Gum Scissors

Curved, sharp-sharp points



**WAGNER Plastic Surgery Scissors**

**CS-61-152**

Gum Scissors

Curved, sharp-sharp points, serrated blade



**WAGNER Plastic Surgery Scissors**

**CS-61-153**

Gum Scissors

Curved, sharp-blunt points



**WAGNER Plastic Surgery Scissors**

**CS-61-154**

Gum Scissors

Curved, sharp-blunt points, serrated blade



**WAGNER Plastic Surgery Scissors**

**CS-61-155**

Gum Scissors

Curved, blunt-blunt points



**WAGNER Plastic Surgery Scissors**

**CS-61-156**

Gum Scissors

Curved, blunt-blunt points, serrated blade



**WAGNER Plastic Surgery Scissors**

**CS-61-157**

Gum Scissors

Straight, sharp-sharp points



**WAGNER Plastic Surgery Scissors**

**CS-61-158**

Gum Scissors

Straight, sharp-sharp point, serrated blade



**Delicate Pattern METZENBAUM Scissors**

**CS-61-159**

Gum Scissors Curved

5" (12.7cm)



**Iris Scissors**

**CS-61-160**

Gum Scissors Straight

4" (10.2cm)



**Iris Scissors**

**CS-61-161**

Gum Scissors Curved  
4" (10.5cm)



**Iris Scissors**

**CS-61-162**

Gum Scissors Straight  
4-1/2" (10.58cm)



**Iris Scissors**

**CS-61-163**

Gum Scissors Straight  
4-1/2" (10.58cm)



**Iris Scissors**

**CS-61-164**

Gum Scissors Curved  
4-1/2" (10.58cm)



**Iris Scissors**

**CS-61-165**

Gum Scissors Curved  
4-1/2" (10.58cm)



**Iris Scissors**

**CS-61-166**

Gum Scissors Angled on side  
4-1/2" (10.58cm)



**BROPHY Scissors**

**CS-61-167**

Gum Scissors Straight, sharp points  
5-1/2" (14cm)



**BROPHY Scissors**

**CS-61-168**

Gum Scissors Curved, sharp points  
5-1/2" (14cm)



**GOLDMAN-FOX Scissors**

**CS-61-169**

Gum Scissors Curved fine tips, one serrated  
blade  
4" (10.5cm)



**GOLDMAN-FOX Scissors**

**CS-61-170**

Gum Scissors Curved fine tips, one serrated  
blade  
5-1/2" (14cm)



**KELLY Scissors**

**CS-61-171**

Gum Scissors Sharp points, straight, one  
serrated blade  
6-1/4" (15.9 cm)



**KELLY Scissors**

**CS-61-172**

Gum Scissors  
Sharp points, curved, one serrated blade



**KELLY Scissors**

**CS-61-173**

Gum Scissors

Sharp points, angular, one serrated blade



**Iris Operating Scissors**

**CS-61-174**

Gum Scissors Curved sideways

4-3/5" (14cm)



**GOLDMAN-FOX Scissors**

**CS-61-175**

Gum Scissors Curved, one serrated blade,  
angled shank

4-1/2" (10.58cm)



**LA GRANGE Scissors**

**CS-61-176**

Gum Scissors

Curved, one serrated blade, angled shank



**BROPHY Operating Scissors**

**CS-61-177**

Gum Scissors Curved, sharp/sharp, with one  
serrated blade

5-1/2" (14cm)



**LOCKLIN Operating Scissors**

**CS-61-178**

Gum Scissors

Angled on side 25 degrees, one serrated blade



**LOCKLIN Operating Scissors**

**CS-61-179**

Gum Scissors

Curved shank, angled on side 25 degrees, one serrated blade



**MILTEX SuperCut GOLDMAN-FOX  
Gum Scissors**

**CS-61-180**

Gum Scissors

Curved



**HEATH Suture Scissors**

**CS-61-181**

Gum Scissors Serrated blade

6-1/8" (15.6cm)



**Iris Scissors**

**CS-61-182**

Gum Scissors Straight, with 20 mm blades, delicate

3-1/2" (8.9 cm)



**Iris Scissors**

**CS-61-183**

Gum Scissors Curved, with 20 mm blades, delicate

3-1/2" (8.9 cm)



**NOYES (ROSS) Iris Scissors**

**CS-61-184**

Gum Scissors

Curved, sharp/sharp points



**CASTROVIEJO Corneal Scissors**

**CS-61-185**

Gum Scissors Curved, sharp points  
4-3/4" (.5cm)



**QUIMBY Gum Scissors**

**CS-61-186**

Gum Scissors  
Strongly curved and pointed, smooth blades 15  
mm



**JOSEPH Scissors**

**CS-61-187**

Gum Scissors Straight  
5-1/2" (14cm)



**JOSEPH Scissors**

**CS-61-188**

Gum Scissors Curved  
5-1/2" (14cm)

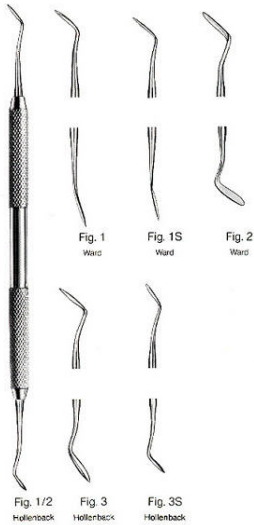

**Hollenback**

**CS-62-101**

Amalgam Instruments

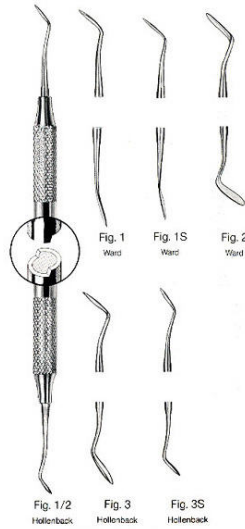

**Hollenback**

**CS-62-107**

Amalgam Instruments



**Mortonson 1**

**CS-62-113**

Amalgam Instruments



**Amalgam Instruments**

**CS-62-114**

Amalgam Instruments

Fig -2



**Amalgam Instruments**

**CS-62-115**

Amalgam Instruments

Fig -3



**Amalgam Instruments**

**CS-62-116**

Amalgam Instruments

Fig -4





Fig. 3-SHO

**Amalgam Instruments**

**CS-62-118**

Amalgam Instruments

Fig -3-SHO



Fig. SHO-A

**Amalgam Instruments**

**CS-62-117**

Amalgam Instruments

Fig -SHO-A



Fig. 104

**Amalgam Instruments**

**CS-62-119**

Amalgam Instruments

Fig-104



Fig. 8

**Amalgam Instruments**

**CS-62-120**

Amalgam Instruments

Fig -8



Fig. 1

**Amalgam Instruments**

**CS-62-121**

Amalgam Instruments

Fig -1



Fig. 2

**Amalgam Instruments**

**CS-62-122**

Amalgam Instruments

Fig -2



Fig 3

**Amalgam Instruments**

**CS-62-123**

Amalgam Instruments

Fig -3



Fig 4

**Amalgam Instruments**

**CS-62-124**

Amalgam Instruments

Fig -4



Fig. SHO-A

**Amalgam Instruments**

**CS-62-125**

Amalgam Instruments

Fig -SHO-A



Fig. 3-SHO

**Amalgam Instruments**

**CS-62-126**

Amalgam Instruments

Fig -3-SHO



Fig. 104

**Amalgam Instruments**

**CS-62-127**

Amalgam Instruments

Fig -104



Fig. 8

**Amalgam Instruments**

**CS-62-128**

Amalgam Instruments

Fig -8



Fig. 1

**Amalgam Instruments**

**CS-62-129**

Amalgam Instruments

Fig -1



Fig. 2

**Amalgam Instruments**

**CS-62-130**

Amalgam Instruments

Fig -2



Fig. 3

**Amalgam Instruments**

**CS-62-131**

Amalgam Instruments

Fig -3



Fig. 4

**Amalgam Instruments**

**CS-62-132**

Amalgam Instruments

Fig -4



Fig. 1

**Amalgam Instruments**

**CS-62-133**

Amalgam Instruments

Fig -1



Fig. 2

**Amalgam Instruments**

**CS-62-134**

Amalgam Instruments

Fig -2



Fig. 3

**Amalgam Instruments**

**CS-62-135**

Amalgam Instruments

Fig -3



Fig. 4

**Amalgam Instruments**

**CS-62-136**

Amalgam Instruments

Fig -4



Ivory Fig. 8  
5 mm  
6 mm  
7 mm

**Toffemire-Universal**

**CS-62-137**

Amalgam Instruments



Nyström I + II

Ivory Fig. 1

Ivory Fig. 12

**Amalgam Instruments**

**CS-62-142**

Amalgam Instruments

Levory Fig -1Levory Fig -2



**Amalgam Instruments**

**CS-62-143**

Amalgam Pistolen

210mm



**Amalgam Instruments**

**CS-62-144**

Amalgam Pistolen

185mm



**Amalgam Instruments**

**CS-62-145**

Amalgam Pistolen



**Amalgam Instruments**

**CS-62-146**

Amalgam Pistolen

145mm



**Amalgam Carrier**

**CS-62-147**

Amalgam Carrier

Fig -1Fig -2Fig -4Fig -5



**Amalgam Carrier**

**CS-62-148**

Amalgam Carrier

Fig -1Fig -2Fig -3



**Amalgam Carrier**

**CS-62-149**

Amalgam Carrier

Fig -1Fig -2Fig -3



**Heister**

**CS-63-141**

Mouth Gags,  
5"130mm



**MOLT PEDIATRIC**

**CS-63-142**

Mouth Gags,  
4"100mm



**MOLT CHILD**

**CS-63-143**

Mouth Gags,  
120 mm4"



**MOLT ADULT**

**CS-63-144**

Mouth Gags,  
9"140mm



**FERGUSON-ACKLAND**

**CS-63-145**

Mouth Gags,  
145mm5"



**DENHART**

**CS-63-146**

Mouth Gags,  
5"125 mm



**ROSER-KONIG**

**CS-63-148**

Mouth Gags,  
7"185mm



**LANGENBECK**

**CS-63-149**

Finger Protectors  
7"180mm



**Tongue Depressor And Cheek Retractors**

**CS-63-150**

Tongue Depressor and Cheek Retractors

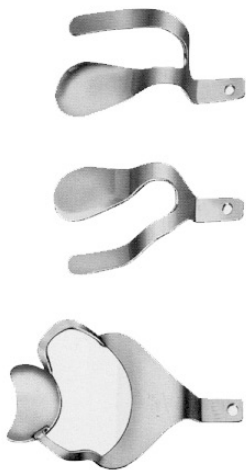

**Retractor**

**CS-63-151**

Mouth Gags,



**HARTMANN**

**CS-63-152**

Retractors  
145mm5"



**Retractor**

**CS-63-153**

Mouth Gags,  
5"140mm



**SCHMID**  
**CS-63-154**  
Mouth Gags,



**Retractor**  
**CS-63-155**  
Mouth Props  
5"140mm



**Retractor**  
**CS-63-156**  
Retractors  
6"160mm



**VESTIBULUM RETRACTOR**  
**CS-63-157**  
Retractors



**STERNBERG**  
**CS-63-158**  
Retractors



**ROUX**  
**CS-63-159**  
Retractors  
23cm 36 x 30





**ROUX**  
**CS-63-160**  
Retractors



**ROUX**  
**CS-63-161**  
Retractors



**MIDDELDORPF**  
**CS-63-162**  
Retractors  
200mm



**MIDDELDORPF**  
**CS-63-163**  
Retractors  
8"210mm



**MIDDELDORPF**  
**CS-63-164**  
Cheek Retractors  
9"230mm



**Gauze Case**  
**CS-63-165**  
Gauze Case  
9"26x30mm230mm



**Retractor**  
**CS-63-166**  
Retractors  
5"165mm



**Retractor**  
**CS-63-167**  
Retractor  
6"165mm



**Retractor**  
**CS-63-168**  
Retractor  
6"165mm



**Retractor**  
**CS-63-169**  
Retractor  
6"165mm



**Retractor**  
**CS-63-170**  
Retractor  
6"165mm



**Retractor**  
**CS-63-171**  
Retractor  
6"165mm



**Retractor**  
**CS-63-172**  
Retractors  
6"165mm



**Retractor**  
**CS-63-173**  
Retractors  
6"165mm

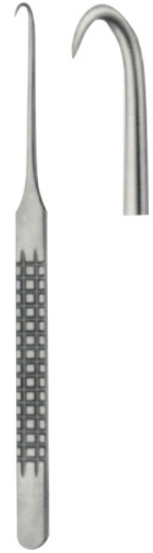

**Retractor**  
**CS-63-174**  
Retractors  
6"160mm



**Retractor**  
**CS-63-175**  
Retractors  
6"160mm



**LANGENBECK-GREEN**  
**CS-63-176**  
Retractors



Fig. 77  
1182/101  
Kirkland

**Kirkland**  
**CS-64-101**

Periodontia Instruments



Fig. 112  
Orban

**Orban**  
**CS-64-102**

Periodontia Instruments



Fig. 112  
Orban

**Orban**  
**CS-64-104**

Periodontia Instruments



Fig. 7  
Goldman-Fox

**Goldman-Fox**  
**CS-64-105**

Periodontia Instruments



Fig. 8  
Goldman-Fox

**Goldman-Fox**  
**CS-64-106**

Periodontia Instruments



Fig. 9  
Goldman-Fox

**Goldman-Fox**  
**CS-64-107**

Periodontia Instruments



Fig. 1/2  
115/2 6/3  
Kirkland

**Kirkland**

**CS-64-103**

Periodontia Instruments



Fig. 11  
Goldman-Fox

**Goldman-Fox**

**CS-64-108**

Periodontia Instruments



Fig. 3/4  
Buck

**Buck**

**CS-64-109**

Periodontia Instruments

Fig -3/4



Fig. 5/6  
Buck

**Buck**

**CS-64-110**

Periodontia Instruments

Fig -5/6



Fig. 7  
Goldman-Fox

**Goldman-Fox**

**CS-64-111**

Periodontia Instruments



Fig. 8  
Goldman-Fox

**Goldman-Fox**

**CS-64-112**

Periodontia Instruments



Fig. 9  
Goldman-Fox

**Goldman-Fox**

**CS-64-113**

Periodontia Instruments



Fig. 11  
Goldman-Fox

**Goldman-Fox**

**CS-64-114**

Periodontia Instruments



Fig. 3/4  
Buck

**Buck**

**CS-64-115**

Periodontia Instruments

Fig -3/4



Fig. 5/6  
Buck

**Buck**

**CS-64-116**

Periodontia Instruments

Fig -5/6



Fig. 1/2  
Sanders

**Sanders**

**CS-64-117**

Periodontia Instruments



Fig. 4/5  
Sanders

**Sanders**

**CS-64-118**

Periodontia Instruments



Fig. 10/20

**OCHSENBEIN CHISEL NO 4**

**CS-64-119**

Periodontia Instruments



Fig. 5/6  
Back

**Crane-Kaplan**

**CS-64-120**

Periodontia Instruments

Fig -5/6



Fig. 1/2  
Sander

**Sanders**

**CS-64-121**

Periodontia Instruments



Fig. 4/5  
Sander

**Sanders**

**CS-64-122**

Periodontia Instruments



Fig. 10/20

**OCHSENBEIN CHISEL NO 4**

**CS-64-123**

Periodontal Instruments



Fig. CK3  
Crane-Kaplan

**Crane-Kaplan**

**CS-64-124**

Periodontia Instruments

Fig -CK3



Fig. HU 1/2  
Curette

**Curette**

**CS-64-125**

Periodontia Instruments

Fig -HU 1/2



Fig. 2R/2L  
Columbia

**Columbia**

**CS-64-126**

Periodontia Instruments

Fig -2R/2L



Fig. 4R/4L  
Columbia

**Columbia**

**CS-64-127**

Periodontia Instruments

Fig -4A/4L



Fig. 13/14  
Columbia

**Columbia**

**CS-64-128**

Periodontia Instruments

Fig -13/14



Fig. 411/412

**Periodontia Instruments**

**CS-64-129**

Periodontia Instruments



Fig. 413/414

**Periodontia Instruments**

**CS-64-130**

Periodontia Instruments





Zerling-Chiles

**Zerling-Chiles**

**CS-64-131**

Periodontia Instruments



Fig. HU 1/2  
Curette

**Curette**

**CS-64-132**

Periodontia Instruments

Fig -HU 1/2



Fig. 2R/2L  
Columbia

**Columbia**

**CS-64-133**

Periodontia Instruments

Fig -2R/2L



Fig. 4R/4L  
Columbia

**Columbia**

**CS-64-134**

Periodontia Instruments

Fig -4A/4L



Fig. 13/14  
Columbia

**Columbia**

**CS-64-135**

Periodontia Instruments

Fig -13/14



Fig 1/2  
Langer

**Langer**

**CS-64-136**

Periodontia Instruments



Fig. 3/4  
Langer

**Langer**

**CS-64-137**

Periodontia Instruments



Fig. 1/2  
Barnhart

**Barnhart**

**CS-64-138**

Periodontia Instruments

Fig -1/2



Fig. 5/6  
Barnhart

**Barnhart**

**CS-64-139**

Periodontia Instruments

Fig -5/6



Fig. ME-1  
(10/11)

**Periodontia Instruments**

**CS-64-140**

Periodontia Instruments



Fig. 3/4  
Hup (22x25)

**Periodontia Instruments**

**CS-64-141**

Periodontia Instruments



Fig. 1/2  
Langer

**Langer**

**CS-64-142**

Periodontia Instruments



Fig. 3/4  
Langer

**Langer**

**CS-64-143**

Periodontia Instruments



Fig. 1/2  
Barnhart

**Barnhart**

**CS-64-144**

Periodontia Instruments

Fig -1/2



Fig. 5/6  
Barnhart

**Barnhart**

**CS-64-145**

Periodontia Instruments

Fig -5/6



Fig ME-1  
[50/11]

**Periodontia Instruments**

**CS-64-146**

Periodontia Instruments



Fig. 3/4  
Rue [227/4]

**Periodontia Instruments**

**CS-64-147**

Periodontia Instruments



Fig. 1/2  
Gracey

**Gracey**

**CS-64-148**

Periodontia Instruments



Fig. 3/4  
Gracey

**Gracey**

**CS-64-149**

Periodontia Instruments



Fig. 5/6  
Gracey

**Gracey**

**CS-64-150**

Periodontia Instruments



Fig. 7/8  
Gracey

**Gracey**

**CS-64-151**

Periodontia Instruments



Fig. 9/10  
Gracey

**Gracey**

**CS-64-152**

Periodontia Instruments



Fig. 11/12  
Gracey

**Gracey**

**CS-64-153**

Periodontia Instruments



Fig. 13/14  
Gracey

**Gracey**

**CS-64-154**

Periodontia Instruments



Fig. 1/2  
Gracey

**Gracey**

**CS-64-155**

Periodontia Instruments



Fig. 3/4  
Gracey

**Gracey**

**CS-64-156**

Periodontia Instruments



Fig. 5/6  
Gracey

**Gracey**

**CS-64-157**

Periodontia Instruments



Fig. 7/8  
Gracey

**Gracey**

**CS-64-158**

Periodontia Instruments



Fig. 9/10  
Gracey

**Gracey**

**CS-64-159**

Periodontia Instruments



Fig. 11/12  
Gracey

**Gracey**

**CS-64-160**

Periodontia Instruments



Fig. 13/14  
Gracey

**Gracey**

**CS-64-161**

Periodontia Instruments



Fig. 11/14  
Gracey

**Gracey**

**CS-64-162**

Periodontia Instruments



Fig. 12/13  
Gracey

**Gracey**

**CS-64-163**

Periodontia Instruments



Fig. 1  
De Marco

**Ce Marco**

**CS-64-164**

Periodontia Instruments

Fig -1



Fig. 2  
De Marco

**De Marco**

**CS-64-165**

Periodontia Instruments

Fig -1



Fig. 13/14  
Anterior

**Anterior**

**CS-64-166**

Periodontia Instruments

Fig -13/14



Fig. 17/18  
Posterior

**Posterior**

**CS-64-167**

Periodontia Instruments



Fig. 11/14  
Gracey

**Gracey**

**CS-64-168**

Periodontia Instruments



Fig. 12/13  
Gracey

**Gracey**

**CS-64-169**

Periodontia Instruments



Fig. 1  
De Marco

**De Marco**

**CS-64-170**

Periodontia Instruments

Fig -1



Fig 2  
De Marco

**De Marco**

**CS-64-171**

Periodontia Instruments

Fig -2



Fig. 13/14  
Anterior

**Anterior**

**CS-64-172**

Periodontia Instruments

Fig -13/14



Fig. 177/18  
Posierior

**Posierior**  
**CS-64-173**

Periodontia Instruments



Fig. 1  
Goldman-Fox

**Goldman-Fox**  
**CS-64-174**

Periodontia Instruments



Fig. 2  
Goldman-Fox

**Goldman-Fox**  
**CS-64-175**

Periodontia Instruments



Fig. 3  
Goldman-Fox

**Goldman-Fox**  
**CS-64-176**

Periodontia Instruments



Fig. 4  
Goldman-Fox

**Goldman-Fox**  
**CS-64-177**

Periodontia Instruments



Fig. 5  
Goldman-Fox

**Goldman-Fox**  
**CS-64-178**

Periodontia Instruments





Fig. 6  
Goldman-Fox

**Goldman-Fox**

**CS-64-179**

Periodontia Instruments



Fig. 71  
Goldman-Fox

**Goldman-Fox**

**CS-64-180**

Periodontia Instruments



Fig. 1  
Goldman-Fox

**Goldman-Fox**

**CS-64-181**

Periodontia Instruments



Fig. 2  
Goldman-Fox

**Goldman-Fox**

**CS-64-182**

Periodontia Instruments



Fig. 3  
Goldman-Fox

**Goldman-Fox**

**CS-64-183**

Goldman-Fox



Fig. 4  
Goldman-Fox

**Goldman-Fox**

**CS-64-184**

Periodontia Instruments



Fig. 5  
Goldman-Fox

**Goldman-Fox**

**CS-64-185**

Periodontia Instruments



Fig. 6  
Goldman-Fox

**Goldman-Fox**

**CS-64-186**

Periodontia Instruments



Fig. 21  
Goldman-Fox

**Goldman-Fox**

**CS-64-187**

Periodontia Instruments



Fig. 11/12  
Mc Call

**Mc Call**

**CS-64-188**

Periodontia Instruments



Fig. 11A/12A  
Mc Call

**Mc Call**

**CS-64-189**

Periodontia Instruments



Fig. 13/14  
Mc Call

**Mc Call**

**CS-64-190**

Periodontia Instruments



Fig. 13S/14S  
Mc Call

**Mc Call**

**CS-64-191**

Periodontia Instruments



Fig. 17S/18S  
Mc Call

**Mc Call**

**CS-64-192**

Periodontia Instruments



Fig. 19/20  
Mc Call

**Mc Call**

**CS-64-193**

Periodontia Instruments



Fig. 11/12  
Mc Call

**Mc Call**

**CS-64-194**

Periodontia Instruments



Fig. 11A/12A  
Mc Call

**Mc Call**

**CS-64-195**

Periodontia Instruments



Fig. 13/14  
Mc Call

**Mc Call**

**CS-64-196**

Periodontia Instruments



Fig. 13S/14S  
McCall

**Mc Call**

**CS-64-197**

Periodontia Instruments



Fig. 17S/18S  
McCall

**Mc Call**

**CS-64-198**

Periodontia Instruments



Fig. 19/20  
McCall

**Mc Call**

**CS-64-199**

Periodontia Instruments



Fig. 2/3  
Taylor

**Taylor**

**CS-64-200**

Periodontia Instruments



Fig. 204S

**Periodontia Instruments**

**CS-64-202**

Periodontia Instruments



Fig. 204S

**Periodontia Instruments**

**CS-64-203**

Periodontia Instruments



Fig. 6  
Crane-Kaplan

**Crane-Kaplan**

**CS-64-204**

Periodontia Instruments

Fig -6



Fig. 7/8  
Younger-Good

**Younger-Good**

**CS-64-205**

Periodontia Instruments



Fig. 2/3  
Taylor

**Taylor**

**CS-64-206**

Periodontia Instruments



Fig. 204

**Periodontia Instruments**

**CS-64-207**

Periodontia Instruments



Fig. 204S

**Periodontia Instruments**

**CS-64-208**

Periodontia Instruments



Fig. 204S

**Periodontia Instruments**

**CS-64-209**

Periodontia Instruments



Fig. 6  
Crane-Kaplan

**Crane-Kaplan**

**CS-64-210**

Periodontia Instruments

Fig -6



Fig. 7/8  
Younger-Good

**Younger-Good**

**CS-64-211**

Periodontia Instruments



Fig. 3/7  
Hirschfeld

**Hirschfeld**

**CS-64-212**

Periodontia Instruments



Fig. 20/31  
Jaquette

**Jaquette**

**CS-64-213**

Periodontia Instruments



Fig. 31/32  
Jaquette

**Jaquette**

**CS-64-214**

Periodontia Instruments



Fig. 31/33  
Jaquette

**Jaquette**

**CS-64-215**

Periodontia Instruments



**Hirschfeld**  
**CS-64-216**

Periodontia Instruments



**Jaquette**  
**CS-64-217**

Periodontia Instruments



**Jaquette**  
**CS-64-218**

Periodontia Instruments



**Jaquette**  
**CS-64-219**

Periodontia Instruments



**Jaquette**  
**CS-64-220**

Periodontia Instruments



**Ochsenbein**  
**CS-64-221**

Periodontia Instruments



Fig. 2  
Ochsenbein

**Ochsenbein**

**CS-64-222**

Periodontia Instruments



Fig. 1  
Gardner

**Gardner**

**CS-64-223**

Periodontia Instruments

Fig -1



Fig. 2  
Gardner

**Gardner**

**CS-64-224**

Periodontia Instruments



Fig. 5  
Gardner

**Gardner**

**CS-64-225**

Periodontia Instruments



Fig. 5R  
Gardner

**Gardner**

**CS-64-226**

Periodontia Instruments



Fig. 6  
Gardner

**Gardner**

**CS-64-227**

Periodontia Instruments





Fig. 1W  
Wakef old

**Wakef Old**

**CS-64-228**

Periodontia Instruments



Fig. 2W  
Wakef old

**Wakef Old**

**CS-64-229**

Periodontia Instruments



Fig. 3  
Buckley

**Buckley**

**CS-64-230**

Periodontia Instruments

Fig -3



Fig. MB  
Molt

**Molt**

**CS-64-231**

Periodontia Instruments



Fig. PR3  
Pricharo

**Pricharo**

**CS-64-232**

Periodontia Instruments



Fig.  
Hopkins

**Hopkins**

**CS-64-233**

Periodontia Instruments



Fig. 2  
Hopkins

**Hopkins**

**CS-64-234**

Periodontia Instruments



Fig. -5  
Frerr

**Frerr**

**CS-64-235**

Periodontia Instruments

Fig -5



Fig. 16  
Frerr

**Frerr**

**CS-64-236**

Periodontia Instruments

Fig -16



Fig. 3  
Mead

**Mead**

**CS-64-237**

Periodontia Instruments



Fig. 23  
Seldin Retractor

**Seldin Retractor**

**CS-64-238**

Periodontia Instruments



Williger  
c/w. 17

**Williger**

**CS-64-239**

Periodontia Instruments



Williger  
cm. 16

**Williger**  
**CS-64-240**

Periodontia Instruments



Williger  
cm. 16

**Williger**  
**CS-64-241**

Periodontia Instruments



Williger  
cm. 13

**Williger**  
**CS-64-242**

Periodontia Instruments



Fig. 1S/2S  
Sugarman

**Sugarman**  
**CS-64-243**

Periodontia Instruments



Fig. 3S/4S  
Sugarman

**Sugarman**  
**CS-64-244**

Periodontia Instruments



Fig. 1/2  
TG Chsel

**TG Chsel**  
**CS-64-245**

Periodontia Instruments



Fig. 1/2  
TG Chisel

**TG Chsel**

**CS-64-246**

Periodontia Instruments



Fig. 1  
TG Chisel

**TG Chsel**

**CS-64-247**

Periodontia Instruments



Fig. 2  
TG Chisel

**TG Chsel**

**CS-64-248**

Periodontia Instruments



Fig. 1  
(15K)  
Kirkland

**Kirkland**

**CS-64-249**

Periodontia Instruments



Fig. 2  
(16K)  
Kirkland

**Kirkland**

**CS-64-250**

Periodontia Instruments



Fig. 1  
Orban

**Orban**

**CS-64-251**

Periodontia Instruments

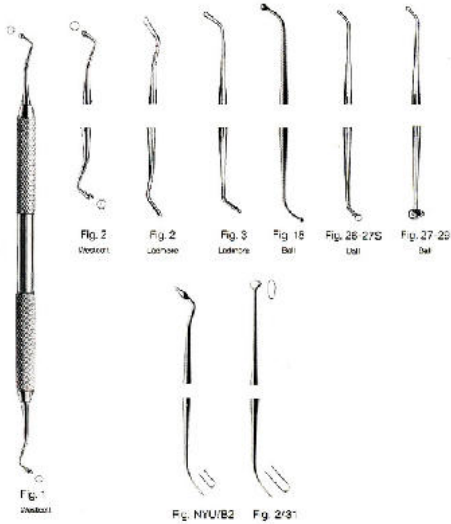

Fig. 2  
Orban

**Orban**

**CS-64-252**

Periodontia Instruments



**Westcott**

**CS-65-101**

Filling instruments

Fig -1

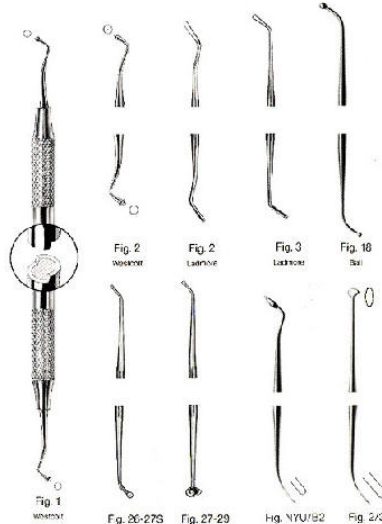

**Westcott**

**CS-65-110**

Filling instruments

Fig -1

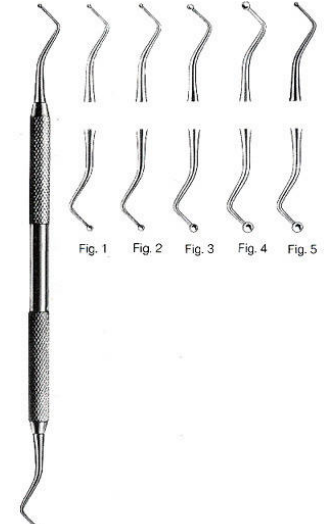

**Filling Instruments**

**CS-65-119**

Filling instruments

Fig -1 Fig -2 Fig -4 Fig -5 Fig -3

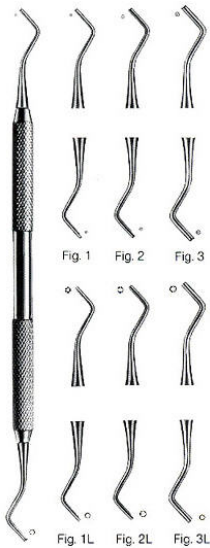

**Filling Instruments**

**CS-65-125**

Filling instruments

Fig -1 Fig -2 Fig -3



**No. 22 Cement Spatula**

**CS-66-101**

No. 22 Cement Spatula



**No. 24A Cement Spatula, Rigid**

**CS-66-102**

No. 24A Cement Spatula, Rigid



**No. 24 Cement Spatula, Flexible**

**CS-66-103**

No. 24 Cement Spatula, Flexible



**No. 313 Cement Spatula,**

**CS-66-104**

No. 313 Cement Spatula,



**No. 5 Cement Spatula**

**CS-66-105**

No. 5 Cement Spatula



**No. 7 Cement Spatula**

**CS-66-106**

No. 7 Cement Spatula

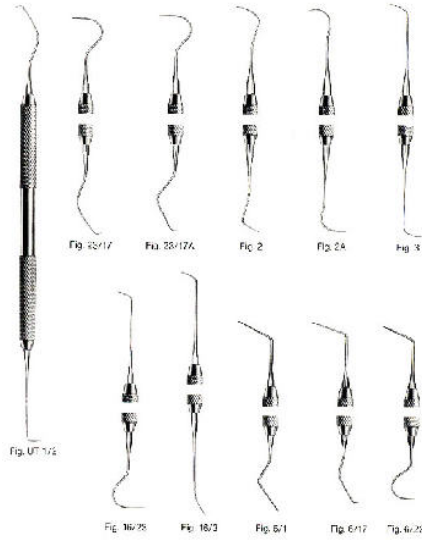

**Single Ended / Double Ended Explorers**

**CS-67-101**

Single Ended / Double Ended Explorers

Fig -UT 1/2

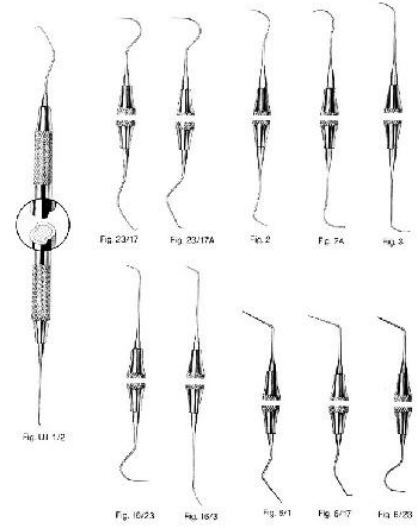

**Single Ended / Double Ended Explorers**

**CS-67-112**

Single Ended / Double Ended Explorers

Fig -UT 1/2





**SIMPLE STEM PLANE 4**

**CS-68-113**  
MOUTH MIRROR



**SIMPLE STEM PLANE 5**

**CS-68-114**  
MOUTH MIRROR



**SIMPLE STEM PLANE 4**

**CS-68-115**  
MOUTH MIRROR



**SIMPLE STEM PLANE 4**

**CS-68-116**  
MOUTH MIRROR



**SIMPLE STEM PLANE 4**

**CS-68-117**  
MOUTH MIRROR



**SECO / CONE-SOCKET**

**CS-68-118**  
Mirror Handles  
5"125 mm



**OCTOGONAL CONE SOCKET**

**CS-68-119**  
Mirror Handles  
120 mm4"



**MARTIN ERGO**

**CS-68-120**  
Mirror Handles  
5"135mm



**Mirror Handles**

**CS-68-121**  
Mirror Handles  
5"135mm



**Mirror Handles**

**CS-68-122**  
Mirror Handle  
5"135mm



**Mirror Handles**

**CS-68-123**  
Mirror Handles  
5"135mm



**Mirror Handles**

**CS-68-124**  
Mirror Handles  
5"135mm



**Napkin Holder**

**CS-68-131**

Napkin Holder

ø 50 mm



**Laryngeal Mirrors**

**CS-68-129**

MIRROR HANDLES

7 mm 30° ø 4



**Cotton Wool Container**

**CS-68-130**

Cotton Wool Container

ø 50 mm



**Laryngeal Mirrors**

**CS-68-128**

MIRROR HANDLES

7 mm 30° ø 4



**MIRROR HANDLE CONE SOCKET**

**CS-53-721-01**

MIRROR HANDLES

14cm/5



**MIRROR HANDLE CONE SOCKET**

**CS-53-721-02**

MIRROR HANDLE CONE SOCKET

14cm/5



**MIRROR HANDLE CONE SOCKET**

**CS-53-723-01**

MIRROR HANDLES

13cm/5



**MIRROR HANDLE**

**CS-53-728-02**

MIRROR HANDLES

12cm



**MARTIN-GRIP**

**CS-53-746-02**

12cm



**MIRROR HANDLE**

**CS-53-755-02**

MIRROR HANDLES

14cm



**MIRROR HANDLE**

**CS-53-757-08**

MIRROR HANDLES

14cm/5



**MIRROR**

**CS-53-702-22**



**MIRROR**  
CS-53-703-22



**RHODIUM MIRROR**  
CS-53-704-10  
MIRROR



**RHODIUM MIRROR**  
CS-53-704-18  
MIRROR

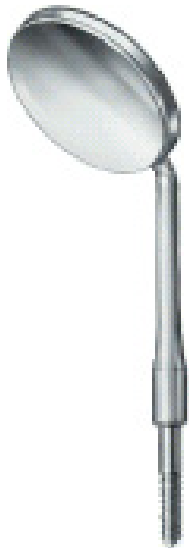

**CONE SOCKET**  
CS-53-706-22  
MIRROR



**CONE SOCKET**  
CS-53-707-22  
MIRROR



**MICRO-MOUTH MIRROR**  
CS-53-710-03

Fig -1



**MICRO-MOUTH MIRROR**

**CS-53-710-05**

Fig -1

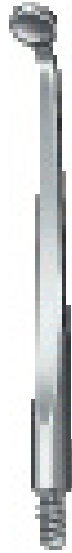

**RHODIUM MICRO MIRROR**

**CS-53-711-03**

Fig -1



**HILGER**

**CS-53-715-00**

18cm /7



**HILGER**

**CS-53-715-01**

CHEEK RETRACTORS



Fig. 1  
Spreader

**Root Spreader Fig 1**

**CS-69-101**

Endodontic Instruments

Fig -1



Fig. 2  
Spreader

**Root Spreader Fig 2**

**CS-69-102**

Endodontic Instruments

Fig -2



Fig. 2  
Spreader

**Root Spreader Fig 3**

**CS-69-103**

Endodontic Instruments

Fig -3



Fig. 4  
Spreader

**Root Spreader Fig 4**

**CS-69-104**

Endodontic Instruments

Fig -4



Fig. 5  
Spreader

**Root Spreader Fig 5**

**CS-69-105**

Endodontic Instruments

Fig -5



Fig. 6  
Spreader

**Root Spreader Fig 6**

**CS-69-106**

Endodontic Instruments

Fig -6



Fig. 7  
Spreader

**Root Spreader Fig 7**

**CS-69-107**

Endodontic Instruments

Fig -7



Fig. 1  
Luks

**Luks Fig 1**

**CS-69-108**

Endodontic Instruments

Fig -1



Fig. 2

**LUKS Fig 2**

**CS-69-109**

Endodontic Instruments

Fig -2



Fig. 3

**LUKS Fig 3**

**CS-69-110**

Endodontic Instruments

Fig -3



Fig. 4

**LUKS Fig 4**

**CS-69-111**

Endodontic Instruments

Fig -4



Fig. 1

**Vertical Condenser Fig 1**

**CS-69-112**

Endodontic Instruments

Fig -1





Fig. 2

**Vertical Condenser Fig 2**

**CS-69-113**

Endodontic Instruments

Fig -2



Fig. 3

**Vertical Condenser Fig 3**

**CS-69-114**

Endodontic Instruments

Fig -3



Fig. 6/1

**Root Canal Explorer Fig 6/1**

**CS-69-116**

Endodontic Instruments

Fig -6/1



Fig. 6/17

**Root Canal Explorer Fig 6/17**

**CS-69-117**

Endodontic Instruments

Fig -6/17



Fig. 6/23

**Root Canal Explorer Fig 6/23**

**CS-69-118**

Endodontic Instruments

Fig -6/23



Fig. 31L

**Root Canal Excavators Fig 31L**

**CS-69-119**

Endodontic Instruments

Fig -31



Fig. 32L

**Root Canal Excavators Fig 32L**

**CS-69-120**

Endodontic Instruments

Fig -32L



Fig. 33L

**Root Canal Excavators Fig 33L**

**CS-69-121**

Endodontic Instruments

Fig -33L



Fig. 6/1

**Root Canal Explorers Fig 6/1**

**CS-69-122**

Endodontic Instruments

Fig -6/1



Fig. 6/17

**Root Canal Explorers Fig 6/17**

**CS-69-123**

Endodontic Instruments

Fig -6/17



Fig. 6/23

**Root Canal Explorers Fig 6/23**

**CS-69-124**

Endodontic Instruments

Fig -6/23



Fig. 31L

**Root Canal Excavators Fig 31L**

**CS-69-125**

Endodontic Instruments

Fig -31L



Fig. 32L

**Root Canal Excavators Fig 32L**

**CS-69-126**

Endodontic Instruments

Fig -32L



Fig. 33L

**Root Canal Excavators Fig 33L**

**CS-69-127**

Endodontic Instruments

Fig -33L



**Heidemann**

**CS-70-101**

Separating Spatulas

Fig -1



**Heidemann**

**CS-70-102**

Separating Spatulas

Fig -2



**Heidemann**

**CS-70-104**

Separating Spatulas

Fig -4



**Heidemann**

**CS-70-105**

Separating Spatulas

Fig -5



**Heidemann**

**CS-70-106**

Separating Spatulas

Fig -6



**Heidemann**

**CS-70-107**

Separating Spatulas

Fig -7



**Heidemann**

**CS-70-108**

Separating Spatulas

Fig -8



**Heidemann**

**CS-70-109**

Separating Spatulas

Fig -9



**Heidemann**

**CS-70-110**

Separating Spatulas

Fig -1



**Heidemann**

**CS-70-111**

Separating Spatulas

Fig -2



**Heidemann**

**CS-70-112**

Separating Spatulas

Fig -3



Fig. 0

**Excavators Fig 0**

**CS-71-101**  
Excavators



Fig. 1

**Excavators Fig 1**

**CS-71-102**  
Excavators

Fig -1



Fig. 2

**Excavators Fig 2**

**CS-71-103**  
Excavators

Fig -2



Fig. 3

**Excavators Fig 3**

**CS-71-104**  
Excavators

Fig -3



Fig. 4

**Excavators Fig 4**

**CS-71-105**  
Excavators

Fig -4



Fig. 5

**Excavators Fig 5**

**CS-71-106**  
Excavators

Fig -5



Fig 6

**Excavators Fig 6**

**CS-71-107**

Excavators

Fig -6



Fig. 0

**Excavators Fig 0**

**CS-71-108**

Excavators



Fig. 1

**Excavators Fig 1**

**CS-71-109**

Excavators

Fig -1



Fig. 2

**Excavators Fig 2**

**CS-71-110**

Excavators

Fig -2



Fig. 3

**Excavators Fig 3**

**CS-71-111**

Excavators

Fig -3



Fig. 4

**Excavators Fig 4**

**CS-71-112**

Excavators

Fig -4



Fig. 5

**Excavators Fig 5**

**CS-71-113**

Excavators

Fig -5



Fig. 6

**Excavators Fig 6**

**CS-71-114**

Excavators

Fig -6



Fig. 6

**Excavators Fig 6**

**CS-71-115**

Excavators

Fig -6



Fig. 14

**Excavators Fig 14**

**CS-71-116**

Excavators

Fig -14



Fig. 17

**Excavators Fig 17**

**CS-71-117**

Excavators

Fig -17



Fig. 17W

**Excavators Fig 17W**

**CS-71-118**

Excavators

Fig -17W





Fig. 18

**Excavators Fig 18**

**CS-71-119**

Excavators

Fig -18



Fig. 18W  
Oval spoon

**Oval Spoon Fig 18W**

**CS-71-120**

Excavators



Fig. 19

**Excavators Fig 19**

**CS-71-121**

Excavators

Fig -19



Fig. 19W  
Oval spoon

**Oval Spoon Fig 19W**

**CS-71-122**

Excavators



Fig. 6

**Excavators Fig 6**

**CS-71-123**

Excavators

Fig -6



Fig. 14

**Excavators Fig 14**

**CS-71-124**

Excavators

Fig -14



Fig. 17

**Excavators Fig 17**

**CS-71-125**

Excavators

Fig -17



Fig. 17W  
Oval spoon

**Oval Spoon Fig 17W**

**CS-71-126**

71-126



Fig. 18W  
Oval spoon

**Oval Spoon 18W**

**CS-71-127**

Excavators



Fig. 19

**Excavators Fig 19**

**CS-71-129**

Excavators

Fig -19



Fig. 19W  
Oval spoon

**Oval Spoon Fig 19W**

**CS-71-130**

Excavators



Fig. 38/39

**Excavators Fig 38/39**

**CS-71-131**

Excavators

Fig -38/39



Fig. 63/64

**Excavators Fig 63/64**

**CS-71-133**

Excavators

Fig 63/64



Fig. 65/66

**Excavators Fig 65/66**

**CS-71-134**

Excavators



Fig. 31L

**Excavators Fig 31L**

**CS-71-135**

Excavators

Fig -31L



Fig. 32L

**Excavators Fig 32L**

**CS-71-136**

Excavators

Fig -32L



**Cleoid / Discoid**

**CS-71-137**

No. 3/6 Excavator, double end



**Cleoid / Discoid**

**CS-71-138**

No. 89/92 Carver - Discoid " Cleoid " handle



Fig. U15  
Towner

**Towner Fig U15**

**CS-72-104**

Scalers

Fig -U15



Fig. U15/33  
Towner Jaquette

**Towner Jaquette Fig- U15/33**

**CS-72-105**

Scalers

Fig- U15/33



Fig. U15/30  
Towner Jaquette

**Towner Jaquette Fig- 15/30**

**CS-72-106**

Scalers

Fig- 15/30



Fig H5/33

**Fig- H5/33**

**CS-72-107**

Scalers

Fig -H5/33



Fig. H6/H7

**Fig- H6/H7**

**CS-72-108**

Scalers

Fig- H6/H7



Fig. 1/2

**Fig- 1/2**

**CS-72-109**

Scalers

Fig -1/2



Fig. U15/33  
Towner Jaquette

**Towner Jaquette Fig- U15/33**

**CS-72-110**

Scalers

Fig- U15/33



Fig. U15/30  
Towner Jaquette

**Towner Jaquette Fig- U15/30**

**CS-72-111**

Scalers

Fig- U15/30

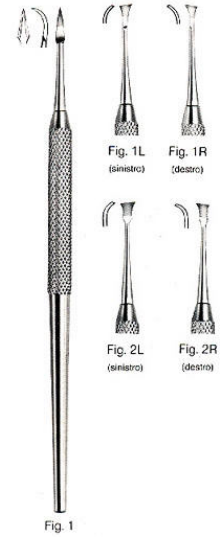

Fig. 1

**Fig- 1**

**CS-72-112**

Scalers

Fig -1



Fig. 33

**Scalers**

**CS-72-117**

Scalers

Fig -33 Fig -31 Fig -32 Fig -34 Fig -35



Fig. H5  
Hygienist

**Hygienist Fig- H5**

**CS-72-122**

Scalers

Fig -H5



**P.K. THOMAS CARVERS FIG. 1**  
**CS-73-101**  
P.K.THOMAS WAX AND MODELLING  
CARVERS FIG.1



**P.K. THOMAS CARVERS FIG. 2**  
**CS-73-102**  
P.K.THOMAS WAX AND MODELLING  
CARVERS FIG.2



**P.K. THOMAS CARVERS FIG. 3**  
**CS-73-103**  
P.K.THOMAS WAX AND MODELLING  
CARVERS FIG.3



**P.K. THOMAS CARVERS FIG. 4**  
**CS-73-104**  
P.K.THOMAS WAX AND MODELLING  
CARVERS FIG.4



**P.K. THOMAS CARVERS FIG. 5**  
**CS-73-105**  
P.K.THOMAS WAX AND MODELLING  
CARVERS FIG.5



**P.K.THOMAS INSTRUMENTS**  
**CS-73-106**  
P.K.THOMAS WAX AND MODELLING  
CARVERS FIG.5 SILVER



**P.K.THOMAS INSTRUMENTS**

**CS-73-107**

P.K.THOMAS WAX AND MODELLING  
CARVERS FIG.4 RED



**P.K.THOMAS INSTRUMENTS**

**CS-73-108**

P.K.THOMAS WAX AND MODELLING  
CARVERS FIG.3 BLUE



**P.K.THOMAS INSTRUMENTS**

**CS-73-109**

P.K.THOMAS WAX AND MODELLING  
CARVERS FIG.2 GOLD



**P.K.THOMAS INSTRUMENTS**

**CS-73-110**

P.K.THOMAS WAX AND MODELLING  
CARVERS FIG.1 GREEN



**FAHNENSTOCK Wax Carver 5 1/4" Knife, 5 1/4", Small**

**CS-73-111**

FAHNENSTOCK Wax Carver 5 1/4" Knife, 5 1/4",  
small



**FAHNENSTOCK Wax Carver 6 3/4" Knife, 6-3/4", Large**

**CS-73-112**

FAHNENSTOCK Wax Carver 6 3/4" Knife, 6-3/4", large



**Impression Trays**

**CS-74-101**

Impression Trays

66x55mm



**Impression Trays**

**CS-74-102**

Impression Trays

62x50mm



**Impression Trays**

**CS-74-103**

Impression Trays

64x50mm



**Impression Trays**

**CS-74-104**

Impression Trays

65x46mm



**Impression Trays**

**CS-74-105**

Impression Trays

69x54mm



**Impression Trays**

**CS-74-106**

Impression Trays

65x46mm





**Impression Trays**

**CS-74-107**

Impression Trays

70x48mm



**Impression Trays**

**CS-74-108**

Impression Trays

70x55mm



**Impression Trays**

**CS-74-109**

Impression Trays

59x42mm



**Impression Trays**

**CS-74-110**

Impression Trays

55x37mm



**Impression Trays**

**CS-74-111**

Impression Trays

61x42mm



**Impression Trays**

**CS-74-112**

Impression Trays

44mm



**Impression Trays**

**CS-74-113**

Impression Trays

44mm



**Impression Trays**

**CS-74-114**

Impression Trays

44mm



**Impression Trays**

**CS-74-115**

Impression Trays

66x55mm



**Impression Trays**

**CS-74-116**

Impression Trays

65x46mm



**Impression Trays**

**CS-74-117**

Impression Trays

69x54mm



**Impression Trays**

**CS-74-118**

Impression Trays

69x54mm



**Impression Trays**

**CS-74-119**

Impression Trays

70x48mm



**Impression Trays**

**CS-74-120**

Impression Trays

70x55mm



**Impression Trays**

**CS-74-121**

Impression Trays

55x37mm



**Impression Trays**

**CS-74-122**

Impression Trays

61x42mm



**Impression Trays**

**CS-74-123**

Impression Trays

61x42mm



**Impression Trays**

**CS-74-124**

Impression Trays

61x42mm



**Impression Trays**

**CS-74-125**

Impression Trays



**Dental Syringes**

**CS-75-101**

Dental Syringes

55x37mm



**Dental Syringes**

**CS-75-102**

Dental Syringes

55x37mm



**Self Aspirating 1.8cc**

**CS-75-103**

Dental Syringes

55x37mm



**Cylinder Cartridge Syringe**

**CS-75-104**

Dental Syringes

55x37mm



**Dental Syringes**

**CS-75-106**

Dental Syringes

55x37mm



**Dental Syringes**

**CS-75-107**

Dental Syringes

55x37mm



**C-W 1.8cc**

**CS-75-108**

Dental Syringes

55x37mm



**Dental Syringes**

**CS-75-109**

Dental Syringes

55x37mm



**Dental Syringes**

**CS-75-110**

Dental Syringes

55x37mm



**Dental Syringes**

**CS-75-111**

Dental Syringes

55x37mm



**Dental Syringes**

**CS-75-112**

Dental Syringes

55x37mm



**Dental Syringes**

**CS-75-113**

Dental Syringes

55x37mm



**Dental Syringes**

**CS-75-118**

Dental Syringes

Fig -1Fig -2Fig -4Fig -3



**Dental Syringes**

**CS-75-119**

Aspira-Plus

1.8 ml



**Dental Syringes**

**CS-75-120**

Dental Syringes

1.8 ml



**Dental Syringes**

**CS-75-122**

Dental Syringes

1.8 ml



**Dental Syringes**

**CS-75-124**

Dental Syringes

1.8 ml



**Dental Syringes**

**CS-75-126**

Dental Syringes

18 ml



**Dental Syringes**

**CS-75-127**

Dental Syringes

18 ml



**Dental Syringe**

**CS-75-128**

Aspira-Plus

1.8 ml



**Dental Syringe**

**CS-75-129**

Dental Syringe



**Dental Syringe**

**CS-**

Dental Syringe



**Dental Syringe**

**CS-75-131**

Dental Syringe



**Dental Syringe**

**CS-75-132**

Dental Syringe

1 ml



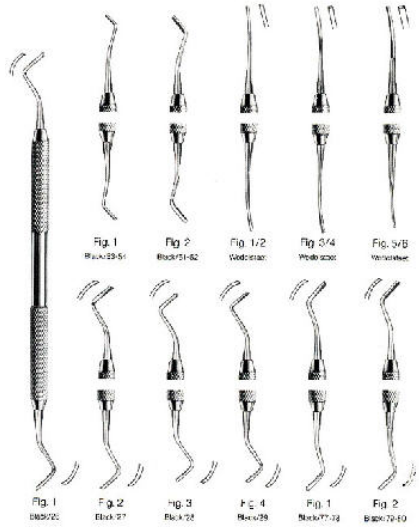

**Wedge/taet**

**CS-76-101**

Cavity Preparation

Fig -1Fig -2Fig -4Fig -5Fig -6Fig -3

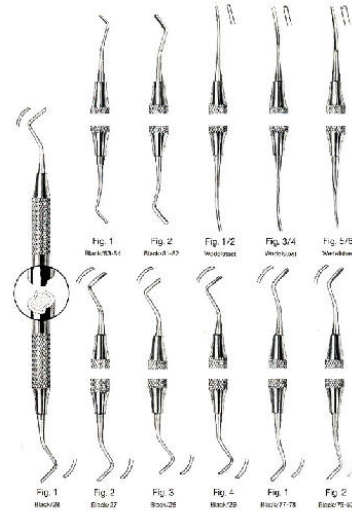

**Wedge/taet**

**CS-76-112**

Cavity Preparation

Fig -1Fig -2Fig -4Fig -5Fig -6Fig -3



**11 Briault D/E Explorer**

**CS-77-101**

FIG. # 11 BRIAULT D/E EXPLORER. MADE OF SOLID STAINLESS STEEL HANDLE



**11/12 Odu D/E Explorer**

**CS-77-102**

FIG. # 11/12 OLD DOMINION UNIVERSITY D/E EXPLORER. MADE OF SOLID STAINLESS STEEL HANDLE



**11/12 Odu D/E After Five Explorer**

**CS-77-103**

FIG. # 11/12 ODU D/E AFTER FIVE EXPLORER. MADE OF SOLID STAINLESS STEEL HANDLE



**2A Pigtail D/E Explorer**

**CS-77-104**

FIG. # 2A PIGTAIL D/E EXPLORER. MADE OF SOLID STAINLESS STEEL HANDLE



**2H D/E Explorer**

**CS-77-105**

FIG. # 2H DE EXPLORER. MADE OF SOLID STAINLESS STEEL HANDLE



**2R/2L D/E Explorer**

**CS-77-106**

FIG. # 2R/2L D/E EXPLORER. MADE OF SOLID STAINLESS STEEL HANDLE



**3 Pigtail D/E Explorer**

**CS-77-107**

FIG. # 3 PIGTAIL D/E EXPLORER. MADE OF SOLID STAINLESS STEEL HANDLE



**3CH Cowhorn D/E Explorer**

**CS-77-108**

FIG. # 3CH COWHORN D/E EXPLORER. MADE OF SOLID STAINLESS STEEL HANDLE



**3ES D/E Explorer**

**CS-77-109**

FIG. # 3ES DE EXPLORER. MADE OF SOLID STAINLESS STEEL HANDLE



**5 D/E Explorer**

**CS-77-110**

FIG. # 5 D/E EXPLORER. MADE OF SOLID STAINLESS STEEL HANDLE



**6/3 D/E Explorer**

**CS-77-111**

FIG. # 6/3 DE EXPLORER. MADE OF SOLID STAINLESS STEEL HANDLE



**17 S/E Explorer**

**CS-77-112**

FIG. # 17 SE EXPLORER. MADE OF SOLID STAINLESS STEEL HANDLE



**23 Shepherd's Hook Explorer**

**CS-77-113**

FIG. # 23 SHEPHERD'S HOOK S/E EXPLORER. MADE OF SOLID STAINLESS STEEL HANDLE



**3 S/E Explorer**

**CS-77-114**

FIG. # 3 SE EXPLORER. MADE OF SOLID STAINLESS STEEL HANDLE



**3A S/E Explorer**

**CS-77-115**

FIG. # 3A S/E EXPLORER. MADE OF SOLID STAINLESS STEEL HANDLE



**54 S/E Explorer**

**CS-77-116**

FIG. # 54 S/E EXPLORER. MADE OF SOLID STAINLESS STEEL HANDLE



**A Tips For MORREL Crown Remover**

**CS-78-101**

A tips for MORREL Crown Remover



**Tips For MORREL Crown Remover**

**CS-78-102**

tips for MORREL Crown Remover



**C Tips For MORREL Crown Remover**

**CS-78-103**

C tips for MORREL Crown Remover



**MORREL Crown Remover, With 3 Points**

**CS-78-104**

MORREL Crown Remover, with 3 points



**WYNMAN Carbide Crown Gripper, 5-1/2", Without Ratchet, With TC Jaws**

**CS-78-105**

WYNMAN Carbide Crown Gripper, 5-1/2", without ratchet, with TC jaws



**X-Ray Film Hangers 6 Clips**

**CS-79-101**

X-RAY FILM HANGERS 6 CLIPS MADE OF STAINLESS STEEL



**X-Ray Film Hangers 10 Clips**

**CS-79-102**

X-RAY FILM HANGERS 10 CLIPS MADE OF STAINLESS STEEL



**Matrix Retainer Toffilemire**

**CS-80-101**

MATRIX BAND RETAINER TOFFILEMIRE.  
AVAILABLE IN STRAIGHT & CONTRA.  
STAINLESS STEEL



**Toffilemire Matrix Retainer Junior / Child**

**CS-80-102**

MATRIX BAND RETAINER TOFFILEMIRE  
JUNIOR / CHILD. AVAILABLE IN STRAIGHT &  
CONTRA. STAINLESS STEEL



**Toffilemire Matrix Retainer Senior / Adult**

**CS-80-103**

MATRIX BAND RETAINER TOFFILEMIRE  
SENIOR / CHILD. AVAILABLE IN STRAIGHT &  
CONTRA. STAINLESS STEEL



**Toffilemire Matrix Retainer Universal**

**CS-80-104**

MATRIX BAND RETAINER TOFFILEMIRE  
UNIVERSAL. AVAILABLE IN STRAIGHT &  
CONTRA. STAINLESS STEEL



**Matrix Band Retainer Ivory 8**

**CS-80-105**

MATRIX BAND RETAINER IVORY 8,  
AVAILABLE IN 5MM, 6MM, 7MM. STAINLESS  
STEEL



**Matrix Band Retainer Ivory Plain**

**CS-80-106**

MATRIX RETAINER IVORY PLAIN / WITHOUT  
LATERAL SHIELD (JAW). STAINLESS STEEL



**Matrix Retainer Ivory With Shield**

**CS-80-107**

MATRIX RETAINER IVORY WITH LATERAL SHIELD (JAW). STAINLESS STEEL



**Matrix Retainer Cheek Protector**

**CS-80-108**

MATRIX BAND RETAINER CHEEK PROTECTOR. STAINLESS STEEL



**Matrix Band Retainer Nystrom Left**

**CS-80-109**

MATRIX BAND RETAINER NYSTROM LEFT. STAINLESS STEEL



**Matrix Band Retainer Nystrom Right**

**CS-80-110**

MATRIX BAND RETAINER NYSTROM RIGHT. STAINLESS STEEL



**Matrix Band Retainer Siqveland (Ash Narrow)**

**CS-80-111**

MATRIX BAND RETAINER SIQVELAND (ASH NARROW). STAINLESS STEEL



**Matrix Band Retainer Siqveland (Ash Wide)**

**CS-80-112**

MATRIX BAND RETAINER SIQVELAND (ASH WIDE). STAINLESS STEEL





**Matrix Band Retainer Ivory Didner (Adjustable)**

**CS-80-113**

Matrix Band Retainer Ivory Didner (Adjustable)



**Matrix Retainer Ivory Separator**

**CS-80-114**

MATRIX BAND RETAINER IVORY SEPARATOR. STAINLESS STEEL



**Matrix Retainer Elliott Separator**

**CS-80-115**

MATRIX RETAINER ELLIOTE SEPARATOR. STAINLESS STEEL



**Matrix Retainer Ivory 8 N**

**CS-80-116**

MATRIX BAND RETAINER IVORY 8N. MADE OF STAINLESS STEEL



**Matrix Retainer Didner 8 P**

**CS-80-117**

MATRIX BAND RETAINER IVORY 8P. MADE OF STAINLESS STEEL

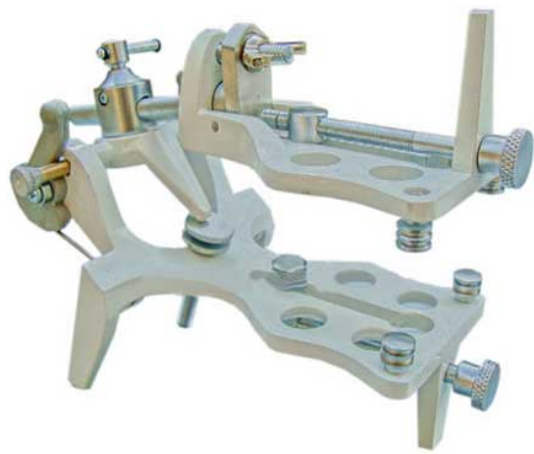

**PLASTERLESS ARTICULATOR GALETTI (WHITE)**

**CS-81-101**

HIGH TECH PLASTERLESS ARTICULATOR GALETTI WITH ADJUSTABLE SCREWS AT REARS & FRONT. SOLIDLY CONSTRUCTED OF METAL ALLOY CASTING. ALL ANATOMICAL MOVEM



**Vibratory Polished Articulator Galetti**

**CS-81-102**

GALETTI ARTICULATOR IS SOLIDLY CONSTRUCTED OF METAL ALLOY CASTING. EASY TO USE, ALLOWING QUICK FIXATION OF MODEL. IMMEDIATE ADJUSTMENT OF THE OCCLU



**ANATOMICAL ARTICULATOR (ASA)**

**CS-81-103**

ANATOMICAL ARTICULATOR WITH BEARING ROD & INCISIVE PIN, 4 MOUNTING PLATES & SUPPORTING BACK-PIN FOR 45° VIEW, OPENING 125°, INTERCONDYLAR DISTANC



**UNIVERSAL ARTICULATOR**

**CS-81-104**

ANATOMICAL ARTICULATOR, MADE OF ALUMINUM PRESSOFUSION OF ONLY 590/GR OF WEIGHT. REALIZED FOR EASY VISIBILITY TO THE LINGUAL SURFACE & FOR A PERFECT



**Gnatus Pro JP30 Articulator**

**CS-81-105**

The Gnatus Pro JP30 Articulator offers the best performance with an excellent degree of accuracy. Its functionality makes easier both the procedure



**ANATOMICAL ARTICULATOR**

**CS-81-106**

ANATOMICAL ARTICULATOR WITH INCISIVE PIN, 4 MOUNTING PLATES AND SUPPORTING BACK-PIN FOR 45° VIEW, OPENING 125°, INTERCONDYLAR DISTANCE 110 MM. ◆



**KEYSTONE BLACK ARTICULATOR  
WIRED**

**CS-81-107**

KEYSTONE DELUXE UNIVERSAL TYPE-A  
ARTICULATOR. INTERCHANGEABLE,  
INCISAL PIN INCLUDED, LATERAL  
EXCURSIONS.



**KEYSTONE DELUXE MAGNET  
ARTICULATOR**

**CS-81-108**

KEYSTONE DELUXE MAGNETIC DENTURE  
ARTICULATOR WITH PLATES,  
INTERCHANGEABLE, INCISAL PIN  
INCLUDED. MAGNETIC SPLIT CASTING  
ENSURES EASY & EXACT SETTING

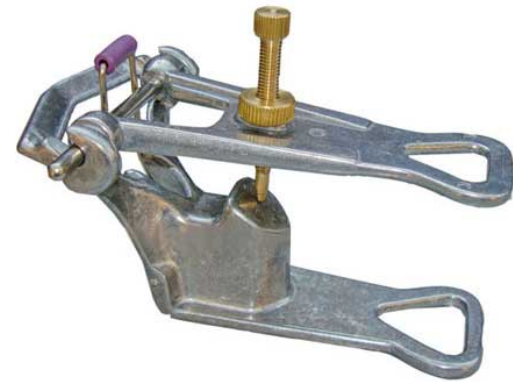

**PROFESSIONAL OCCLUSOR  
ARTICULATOR**

**CS-81-109**

PROFESSIONAL OCCLUSOR, VIBRATORY  
POLISHED ARTICULATOR - ALUMINUM,  
BRASS, STAINLESS STEEL



**Magicart-1 Articulator**

**CS-81-110**

LIGHTWEIGHT, HIGH-QUALITY MAGIC ART  
ARTICULATOR SECURELY HOLDS  
QUADRANT MODELS, CONSERVE  
MATERIALS & TIME! QUICKLY & EASILY  
MOUNT PRE-CAST DENTAL M



**FULL DENTURE ARTICULATOR  
(ROUND)**

**CS-81-111**

FULL DENTURE CHROME PLATED  
ARTICULATOR (3 SLOT ROUND)

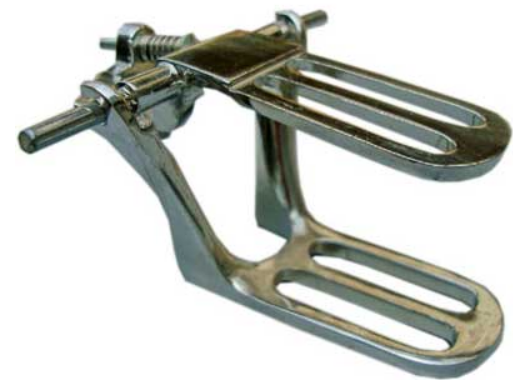

**MODEL 'M' HI TOP STEPHAN  
ARTICULATOR**

**CS-81-112**

FULL DENTURE CHROMIUM PLATED  
ARTICULATOR. PROVIDES ADDITIONAL  
VERTICAL DIMENSION FOR ACCEPTANCE  
OF HIGHER MODELS. 49 WIDE AT THE JOINT  
& HAS A VERT



**Chromium Plated Plain Round**

**CS-81-113**

Nickle Chromium Plated Plain Round Articulator



**UNIVERSAL ARTICULATOR (YELLOW)**

**CS-81-114**

UNIVERSAL ARTICULATOR OPENING 125° WITH 4 MOUNTING PLATES - CONDYLAR INCLINATION FIXED AT 30°, INTERCONDYLAR DISTANCE AT 110MM, BENNET ANGLE FIXED



**FOSTER DENTURE ARTICULATOR**

**CS-81-115**

THIS ARTICULATOR IS EQUIPPED WITH AN ADJUSTABLE ANTERIOR PIN STOP & POSTERIOR SCREW STOP, AND CONSTRUCTED OF A SLIGHTLY HEAVIER GAUGE BRASS GIVING



**FORK CHROME PLATED ARTICULATOR**

**CS-81-116**

NICKLE CHROMIUM PLATED ARTICULATOR FORK PATTERN



**HINGE ARTICULATOR FULL ARCH**

**CS-81-117**

AN ECONOMICAL & SIMPLE CHROMIUM PLATED HINGE ARTICULATOR FOR MOUNTING FULL ARCH CASES. LOW BACK



**QUADRANT / CROWNED BRIDGE ARTICULATOR**

**CS-81-118**

BRASS HINGE CROWNED BRIDGE ARTICULATOR FOR MOUNTING QUADRANT CASES. CROWN & BRIDGE ARTICULATOR IS POPULAR FOSTER # 57 DESIGN, ELIMINATES THE NEED T



**UNIVERSAL ARTICULATOR (BLUE)**

**CS-81-119**

UNIVERSAL ARTICULATOR OPENING 125° WITH 4 MOUNTING PLATES - CONDYLAR INCLINATION FIXED AT 30°, INTERCONDYLAR DISTANCE AT 110MM, BENNET ANGLE FIXED



**FOSTER / APEX # 2 ARTICULATOR**

**CS-81-120**

FOSTER / APEX # 2 ARTICULATOR, THE WIDTH AT THE JOINT IS 1-3/4" WITH A VERTICAL PARALLEL HEIGHT OF 2-1/8". THE SMALL SIZE OF THIS ARTICULATOR A



**MORTIMER-I OCULADER ARTICULATOR**

**CS-81-121**

PLAINLINE BALL BEARING MORTIMER-I OCULADER ARTICULATOR. ALL FILLED WITH HIGH CARBON STEEL BALLS FOR SMOOTH SETTING & ARTICULATION OF DENTURE



**MORTIMER-II OCULADER ARTICULATOR**

**CS-81-122**

PLAINLINE BALL BEARING MORTIMER-II OCULADER ARTICULATOR. ALL FILLED WITH HIGH CARBON STEEL BALLS. SEMI-ADJUSTABLE ARTICULATOR ALLOWS THE ESTABLISHM



**OCCLUSOR, WIRE ARTICULATOR**

**CS-81-123**

OCCLUSOR, WIRE ARTICULATOR - STAINLESS STEEL & ALUMINUM



**ASA Articulator 5002**

**CS-81-124**

ASA ARTICULATOR WITH LATERAL MOMENT. MADE OF ALUMINUM DIE CASTING WITH 2 MOUNTING PLATES. ALSO AVAILABLE IN VIBRATORY POLISHED PROCESS



**Model "A" Crescent Stephan Articulator**

**CS-81-125**

CRESCENT STEPHAN MODEL "A" ARTICULATOR IS USED FOR PARTIALS, CENTER SPRING WITH ADJUSTABLE TENSION, SMOOTH BRASS CASTINGS WITH NICKEL PLATING,



**Bite Fork / Occlusal Alignment Plane**

**CS-81-126**

BITE FORK IS A RELIABLE INSTRUMENT FOR CHECKING THE CORRECT POSITION OF THE MASTICATORY PLANE, ACHIEVING PARALLELISM OF THE OCCLUSAL PLANE WITH THE



**Bandage And Utility Scissors**

**CS-82-101**

Bandage and Utility Scissors, 7-1/2" (19.1 cm), needle destroyer, serrated blade, autoclavable



**Plaster And Compound Knife**

**CS-82-102**

Plaster and Compound Knife



**Soldering Tweezers, Curved**

**CS-82-103**

Soldering Tweezers, curved



**SWISS Jeweler Style Forceps**

**CS-82-104**

SWISS Jeweler style Forceps, non-magnetic stainless steel, style 3, narrow, fine, 4-3/4" (12.1 cm)



**SWISS Jeweler Style Forceps**

**CS-82-105**

SWISS Jeweler style Forceps, non-magnetic stainless steel, style 5, Super fine, 4-3/8" (11.2 cm)



**SWISS Jeweler Style Forceps**

**CS-82-106**

SWISS Jeweler style Forceps, non-magnetic stainless steel, style 7, fine, curved, 4-1/2" (11.4 cm)



**Calipers**

**CS-82-107**

Calipers



**Calipers**

**CS-82-108**

Calipers



**Steel Ruler**

**CS-82-109**

Steel Ruler



**Forceps For Articulation Paper**

**CS-82-110**

Forceps for articulation paper





## ***Get In Touch***

 Champion Surgico. Pacca Garrha,  
P.O Box 2885, Pakistan.

 +92 52 429 3283

 [info@championsurgico.com](mailto:info@championsurgico.com)

 [www.championsurgico.com](http://www.championsurgico.com)

